

MAINTENANCE AND OPERATION
INSTRUCTION MANUAL

DB9000-STC

DSP-Based Stereo Generator
with
RDS/RBDS Encoder



Contents

Introduction	5
Typographic conventions	6
General Information	7
<i>Application</i>	7
Product Features	8
<i>Technical Specifications</i>	9
<i>Block Diagram</i>	11
Safety Precautions	12
Before you start	13
<i>Mains Voltage Selector</i>	13
<i>Power Cord</i>	13
<i>Operating Recommendations</i>	14
<i>Radio Frequency Interference (RFI)</i>	14
Unpacking and Inspection	15
Mounting	15
<i>Rack Requirement</i>	15
<i>Heat Dissipation</i>	15
Panel Indicators and Appointments	16
<i>Front View</i>	16
<i>Rear View</i>	17
Connecting of DB9000-STC	18
<i>Analog Audio Inputs</i>	18
<i>Digital Audio Input</i>	18
<i>LAN Port</i>	18
<i>RS-232 COM Port</i>	18
Operation	19
<i>Status</i>	21
<i>General Configuration</i>	23
<i>Device Alias</i>	23
<i>Date and Time</i>	23
<i>Network Configuration</i>	24
<i>General Network Settings</i>	24
<i>IP Voice Announcement</i>	25
<i>WEB Server Settings</i>	25
<i>FTP Server Settings</i>	25
<i>SNMP Settings</i>	25
<i>Backup Audio Configuration</i>	26
<i>Audio Loss Settings</i>	26
<i>Audio Recover Settings</i>	26
<i>MP3 Audio Player Settings</i>	27
<i>RS-232 COM Port Configuration</i>	28
<i>RS-232 Settings</i>	28
<i>Ethernet to RS-232 Redirector</i>	28
<i>Stereo Encoder Configuration</i>	29
<i>General Settings</i>	29

<i>Audio Input</i>	29
<i>Injection Levels</i>	29
<i>Phase Adjustment</i>	30
<i>MPX Limiter</i>	30
<i>Output Levels</i>	30
<i>Audio Enhancement Configuration</i>	31
<i>Automatic Gain Control Settings</i>	31
<i>Audio Equalizer Settings</i>	32
<i>RDS Encoder Configuration</i>	33
<i>RDS Encoder Settings</i>	33
<i>Program Station Name Settings</i>	33
<i>Radio Text Settings</i>	34
<i>General Settings</i>	34
<i>Traffic Information</i>	35
<i>Decoder Information</i>	36
<i>Date & Time Settings</i>	36
<i>Program Type Name Settings</i>	36
<i>Console Settings</i>	37
<i>AF List Configuration</i>	38
<i>Factory Defaults Settings</i>	39
<i>General Default Settings</i>	40
<i>Network Default Settings</i>	40
<i>Backup Audio Default Settings</i>	40
<i>COM Port Default Settings</i>	41
<i>Stereo Encoder Default Settings</i>	41
<i>Audio Enhancement Default Settings</i>	41
<i>RDS Encoder Default Settings</i>	42
<i>AF List Default Settings</i>	42
<i>Hardware Reset</i>	43
<i>Network Default Settings</i>	43
<i>WEB Server Default Settings</i>	43
<i>Rebooting</i>	44
<i>Firmware Update</i>	45
RDS Console	46
<i>Connecting to the RDS console</i>	46
<i>RDS Console Syntax</i>	46
<i>List of available RDS Console commands and responses</i>	47
UPnP discovery in Local Networks	48
UPnP Activation	49
WARRANTY TERMS AND CONDITIONS	50
Product Registration Card	51

THIS PAGE
IS INTENTIONALLY
LEFT BLANK

Introduction

DEVA Broadcast Ltd. is an international communications and high-technology manufacturing organization, its corporate headquarters and facility located in Burgas, Bulgaria. The company serves the broadcast and corporate markets worldwide – from consumers and small businesses to the largest global organizations. It is dedicated to the research, design, development and provision of advanced products, systems and services. DEVA launched its own brand back in 1997 and has nowadays evolved to become known as a market leader and internationally reputed manufacturer of user-friendly, cost-effective and innovative broadcast products.

Creativity and innovation are deeply woven into DEVA corporate culture. Through successful engineering, marketing and management our team of dedicated professionals creates future-oriented solutions to improve customers' performance. You may rely that all issues communicated to our crew would be addressed accordingly. We pride ourselves on our pre and post-sales support and purchase services, which along with the outstanding quality of our radio gear have won us due respect and the market authority position.

DEVA best-of-breed solutions have become the best sellers for our partners. The strategic partnerships which have been formed with industry leaders during all these years that we have been operating on the broadcasting market, have proved us a reliable business partner and a valuable asset, as our dealers worldwide would confirm. In constant pursuit of precision and long-term satisfaction, DEVA enhances the reputation of our partners and clients alike. Furthermore, we have already a proven merit as a credible partner provider.

Our portfolio offers complete line of high quality and competitive products for FM and Digital Radio, Radio Networks, Telecommunication Operators and regulation authorities. For almost two decades of intensive software and hardware development, we have achieved a unique price-performance and endurance of our product lines. Our company's multitude of equipment and services is in line with the latest technologies and key trends. The most recognizable characteristics attributed to DEVA products are their clear-cut, streamlined design, easiness of use and cost-effectiveness: simplicity of forms but multiplicity of functions.

For us there is no stage when we deem that we have reached the most satisfactory level in our work. Our engineers are in constant pursuit of new ideas and technologies to be captured in DEVA solutions. Simultaneously, a strict control is being exercised at each step of any new development. Experience and hard work are our fundament but the continuous improving process is what we never leave aside. DEVA participates on a regular basis in all landmark broadcasting events, not only to promote its products, but to exchange valuable know-how and experience. We are also engaged in international large-scale projects involving radio and audio solutions which makes us even more competitive on the global market.

All DEVA products are developed and produced in accordance with the latest ISO 9001 quality control standards.

Typographic conventions

This manual uses the following typographic conventions:

Style	Used for
NOTE	Important notes and recommendations
Example	Used when example text is cited
“Menu” on page XX.	References
[OK]	Interface Interactive buttons.
<i>Settings</i>	Menu paths are represented as follows: <i>Settings</i> > <i>General</i> > <i>Backup</i>

General Information

DB9000-STC is a high-performance, 32bits DSP based Stereo Generator with built-in RDS/RBDS encoder. It has been accurately designed to satisfy the most demanding requirements in FM Stereo generation and advanced RDS/RBDS encoding. This Stereo Encoder accept both of types, Analog and Digital AES/EBU audio sources. DB9000-STC comes with easy to use and password protected Web Server and a comprehensive remote control features. It supports SNMP, RS232, UDP, TCP/IP communication protocols. Its digital architecture guarantees long term reliability and easy firmware updates, directly on field or from remote.

The built-in RDS encoder can 'parse' scrolling text, automatically breaking phrases into word groups. It gives dynamic, on-the-fly programming access with its built-in USB, TCP/IP, UDP/IP interfaces. This connectivity permits full integration of RDS/RBDS transmissions with the station's other networked functions, including message streams for digital radio and Webcasting. It can be easily interfaced to various Automation Systems and offers an ASCII protocol for broadcast song/artist information.

Another great feature of the DB9000-STC is that it can fight the dreaded dead air problem. The DB9000-STC provides additional uncompromising security in case of loss of audio at the audio inputs. The audio backup is presented as an integrated built-in MP3 audio player. The basic principle of operation is that this unit can detect the silence and switch the output to the alternative MP3 Player. The MP3 backup audio files and play lists can be uploaded in the device from your PC using any FTP client. The audio storage capacity of DB9000-STC is 2 Giga Bytes.

Based on the latest DSP technology, the DB9000-STC is fully digital design for 24/7/365 operation. This product is the most cost effective, versatile and reliable solution designed for the broadcasters looking for a complete solution for a single, or a multiple transmitter sites.

APPLICATION

- On site DSP-Based Stereo and RDS encoding
- Ethernet to RS-232 Redirector
- Audio Backup on connection or audio loss
- Audio Rebroadcast

Product Features

- Fully Digital 32 bits DSP Stereo Encoder
- Excellent Audio Performances
- Digital Volume Control of all Audio Inputs
- Adjustable Pilot, L-R, RDS phases
- Selectable pre-emphasis 0, 50 μ s, 75 μ s
- Digitally adjustable Pilot & RDS injection levels
- Fully Digital Synthesis of the RDS Signal
- Intelligent Silence Detector and Backup Audio Player
- Configuration and Monitoring via SNMP Ver.2C & WEB
- Alert Notifications via E-mail, SNMP in case of Audio Loss
- Lots of Storage for over 24 hours of non-repeating audio playback
- Always Fresh Backup Audio Tracks with Embedded FTP server
- Professional Balanced Stereo Analog Input on XLR connectors
- Professional Digital AES/EBU Audio input on XLR connectors
- Headphones Jack for local monitoring of the Audio Signal
- Built-in MP3 Player with built in 2GB SD Card
- UPnP for easy discovery in Local Networks
- Professional 19 inches, 1U Professional rack mount chassis
- Remote Firmware Upgrade for future-proof operation
- Protected access to the device settings
- Easy installation and operation
- 2 Years Warranty

TECHNICAL SPECIFICATIONS

ANALOG AUDIO INPUT	
Connector	2 x XLR, Stereo
Type	Balanced
Impedance	600Ω or High Impedance
Level	+6dBu / +12dBu, user selectable
Sample rate	96 kHz; Build-in sample rate converter used to produce lower sample rates
Dynamic range	>100dB
DIGITAL AUDIO INPUT	
Connector	XLR
Type	AES/EBU (IEC 60958)
Resampling	Thru build-in sample rate converter
AUDIO BACKUP	
Trigger	Audio Silence
Threshold	Adjustable, -90dBfs to 0dBfs
Trigger time	Adjustable, 5s to 240s
Storage	SD Card, up to 2GB
Supported file types	*.MP3, *.AAC, *.M4A, *.M3U
Playback modes	Alphabetical ascending and descending, Shuffle, Playlist and Shuffled playlist
Remote file management	Build-in FTP Server
STEREO ENCODER	
Type	Fully DSP Stereo Encoding
Pre-emphasis	0, 50, 75μs
AGC	5 presets, 2 user defined
Equalizer	3-Band, ±12dB range
Stereo separation	>55dB (typically >60dB)
Phase Adjust	Pilot, L-R, RDS
Injection Levels Adjust	Pilot, RDS
Output Connector	BNC, Unbalanced
Output Level Adjust	Digitally, up to 0dBu
Composite MPX Limiter	6 presets, 3 user defined
RDS ENCODER	
Supported RDS Applications	PI, PS, Dynamic PS AF, RT, TP, TA, DI, M/S, PIN, PTY, PTYN
Configuration	Web Interface
Automation control	Remote TCP console
Output Connector	BNC, Unbalanced
Output Level Adjust	Digitally, up to -6dBu

PHONES AUDIO OUTPUT	
Connector	1/4" (6.3mm) Phone Jack, Stereo
Type	Headphones
USER INTERFACE	
Indicators	4 LEDs on front panel, 2 LEDs on rear panel
Web interface	Full control and status information
RS-232	
Type	TCP/IP to RS-232 Redirector
Connector	DB-9, female
Baud rates	9600 to 115200
Password protection	Yes
NETWORK	
Connector	RJ-45
Type	Ethernet

BLOCK DIAGRAM

A simplified block diagram of DB9000-STC is shown below

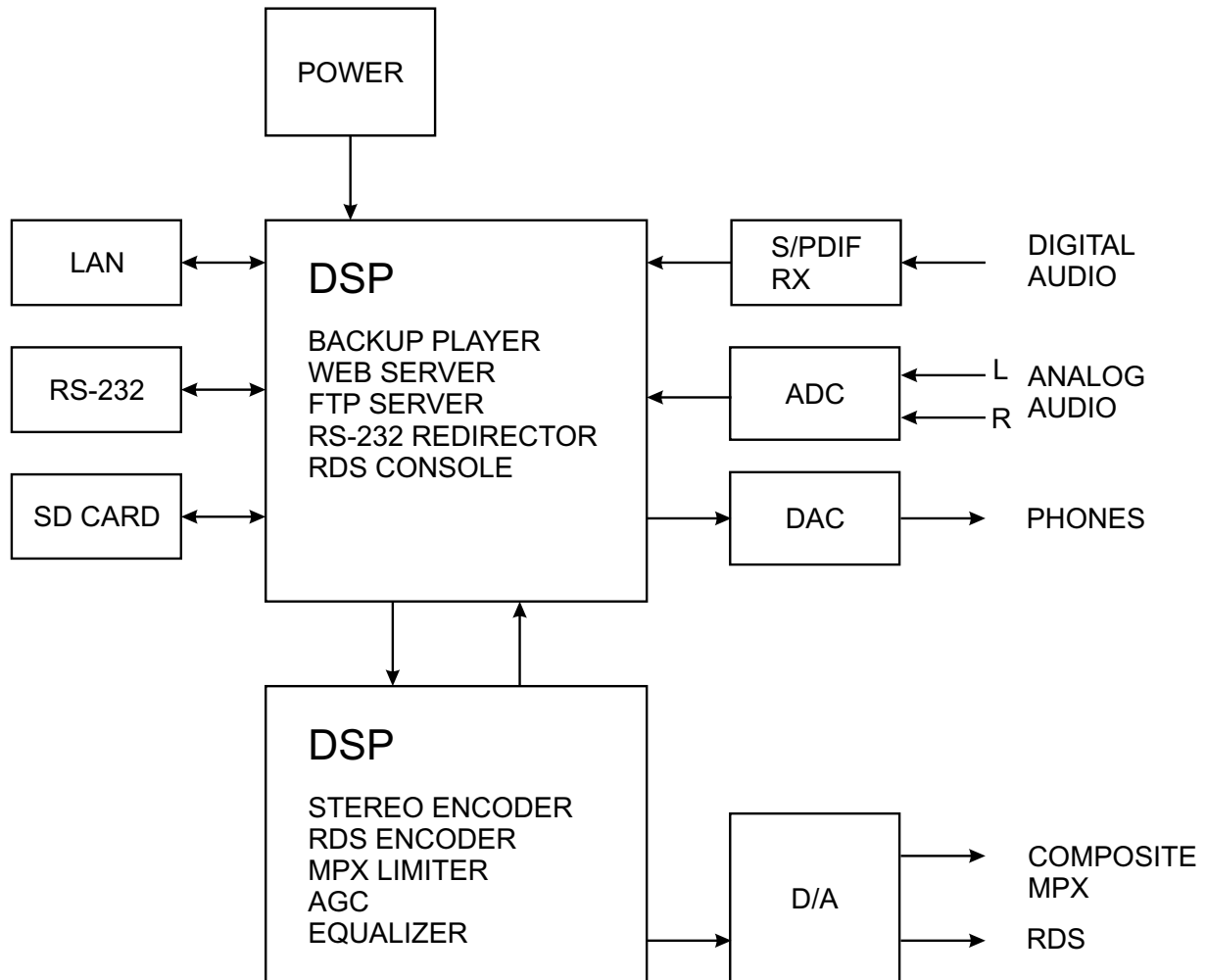

Because of the all-digital, minimalist-discrete-component nature of device circuitry, we have not provided schematic diagrams of the DB9000-STC in this Manual. Please, note that:

**NO USER-SERVICEABLE COMPONENTS INSIDE.
 REFER ALL SERVICING TO
 QUALIFIED TECHNICAL PERSONNEL.**

Safety Precautions

IMPORTANT: *Carefully read this paragraph as it contains important instructions concerning operator safety and directions regarding the installation, operation and maintenance of the equipment. Failure to observe the safety instructions and information given in this manual constitutes an infringement of the safety rules and design specifications provided for this piece of equipment. DEVA Broadcast Ltd. declines all responsibility if any one of the safety rules given herein is not observed. DEVA Broadcast Ltd. declines all responsibility if the end-user resells the product. The equipment is to be used by people capable of operating it in a trouble-free manner and it is assumed that they are aware of the following safety rules.*

- ◇ Keep this manual with the utmost care and close at hand so that it can be consulted whenever needed
- ◇ After unpacking the equipment, check its condition.
- ◇ Avoid banging the equipment.
- ◇ The packing material (plastic bags, polystyrene, nails, etc.) must never be left within reach of children, as these items are potential sources of danger.
- ◇ Do not use the equipment in places where the temperature is not within the recommended range, as specified by the manufacturer.
- ◇ Before connecting the equipment, make sure the nameplate specifications correspond to the mains electricity supply (the nameplate is located on the equipment enclosure).
- ◇ Do not remove the sticker from the equipment as it contains important specifications and the relevant serial number.
- ◇ To join the equipment to the mains supply, use the power cord purchased with the equipment.
- ◇ The equipment must be used only for the purposes it was designed for.
- ◇ Abuse or misuse of the equipment is extremely dangerous for people, pets and property. The manufacturer declines all responsibility for damage and injury resulting from improper use and mishandling.
- ◇ Certain basic safety rules must be observed when using electrical equipment, in particular:
 - Never touch the equipment with wet and/or damp hands or other parts of the body.
 - Keep the equipment away from drops of water or sprinkling systems.
 - Never use the equipment near high heat sources or explosive material.
 - Do not introduce any extraneous matter into the equipment.
 - Do not allow children or untrained people to use the equipment.
- ◇ Before cleaning or servicing the equipment outside, disconnect its power supply and wait at least 2 seconds before working on it, as recommended by current safety regulations.
- ◇ In the event of faults and/or improper operation, turn off the equipment, shut off the electrical power and call your dealer.
- ◇ Do not attempt to make repairs and/or adjustments when covers/guards or circuit boards are to be removed.
- ◇ Call your dealer for any repairs and be certain original spare parts are used. Failure to observe this rule may adversely affect the safety level of your equipment.
- ◇ The equipment is to be connected to the mains supply and provided with adequate and efficient earth conductors.
- ◇ When installing, leave a clearance of at least 1 cm around the equipment to allow air to pass freely.

Before you start

MAINS VOLTAGE SELECTOR

Unless specifically ordered for export shipment, the DB9000-STC is set at the factory for operation from 115V/230V, 50/60Hz AC mains. This can be confirmed by checking the voltage selector inside the unit. To change the mains voltage, first remove the top cover of the unit. A clearly marked slide switch is next to the AC mains connector on the encoder circuit board. *With power disconnected*, use a small screwdriver to set the switch for 115VAC or 230VAC operation. Be sure to install the appropriate fuse, DB9000-STC is equipped at the factory with 1A fuse.

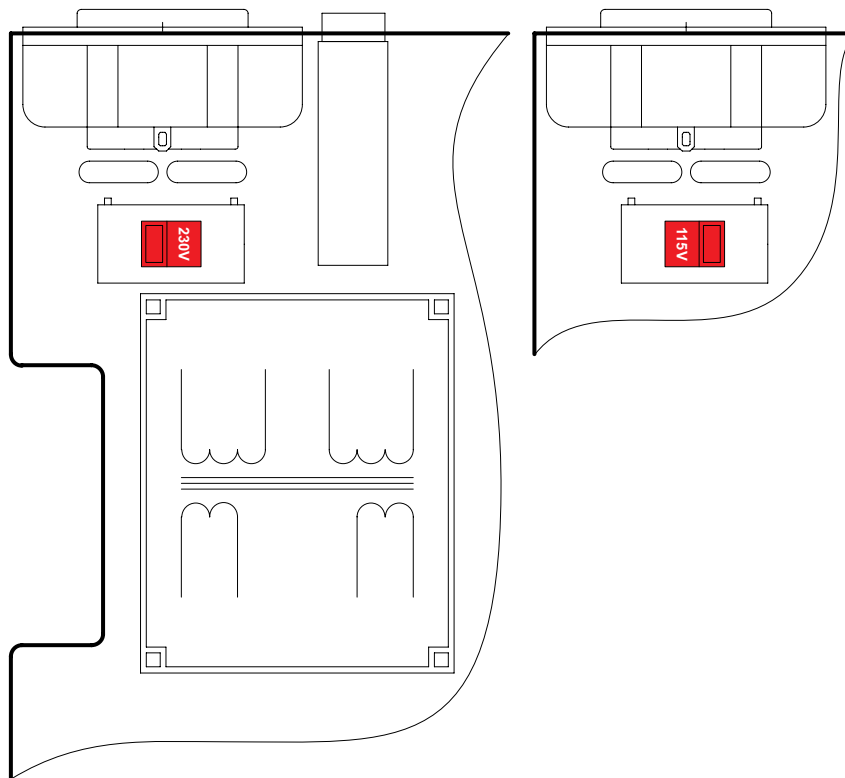

POWER CORD

The detachable IEC-type power cord is supplied with the unit. The individual cord conductors may be color-coded in either of two ways:

1) In accordance with US standards:

BLACK = AC "HOT"

WHITE = AC NEUTRAL

GREEN = EARTH GROUND

2) To European CEE standards:

BROWN = AC "HOT"

BLUE = AC NEUTRAL

GREEN/YELLOW = EARTH GROUND

OPERATING RECOMMENDATIONS

For the normal and reliable operation of the DB9000-STC device we recommend to follow the next list of instructions:

- Please, install the unit only in places with good air conditioning. The unit has been designed for operation within an ambient temperature range extending from 10 to 50°C. But because adjacent, less efficient equipment may radiate substantial second-hand heat, be sure that the equipment rack is adequately ventilated to keep its internal temperature below the specified maximum ambient. When installing, leave a clearance of at least 1 cm around the equipment to allow air to pass freely.
- We do not recommend installation in rooms with high humidity, dusty places or other aggressive conditions.
- Although it is expected that a DB9000-STC will be installed close to exciters (or transmitters of even higher-power!), please practice reasonable care and common sense in locating the unit away from abnormally high RF fields.
- Please, use only already checked power supply cables and sources. The shielded cables usage is strongly recommended.
- We strongly recommend connecting the device only to reliable power supply sources. In case of unstable power supply, please use UPS (Uninterruptible Power Supply).
- Please, use the device only with placed top cover to avoid any electromagnetic anomalies which may cause problems of the normal functionality of the unit.
- Please, connect DB9000-STC only to good quality Internet connection. This is very important for the normal remote operation of the unit.
- Please, check if your network settings pass through all the data traffic required for the normal operation of the DB9000-STC unit.

RADIO FREQUENCY INTERFERENCE (RFI)

Although we have anticipated DB9000-STC installation in the immediate proximity of broadcast transmitters, please do practice some care using the unit away from abnormally high RF fields.

Unpacking and Inspection

IT IS VERY IMPORTANT that the Warranty Registration Card found at the front of this Manual be completed and returned. Not only does this assure coverage of the equipment under terms of the Warranty and provide a means of tracing lost or stolen gear, but the user will be sent specific SERVICE OR MODIFICATION INSTRUCTIONS issued by DEVA Broadcast Ltd.

As soon as the equipment is received, inspect carefully for any shipping damage. If damage is suspected, notify the carrier at once, and then contact DEVA Broadcast Ltd.

We recommend that you retain the original shipping carton and packing materials, just in case return or reshipment becomes necessary. In the event of return for Warranty repair, shipping damage sustained as a result of improper packing for return *may invalidate the Warranty!*

Mounting

RACK REQUIREMENT

The DB9000-STC mounts in a standard 19-inch equipment rack and requires only 1¾ inches (1U) of vertical rack space. The use of plastic washers is recommended to protect the painted finish around the mounting holes.

HEAT DISSIPATION

Consuming less power than the light in a refrigerator, the DB9000-STC itself generates negligible heat. The unit is specified for operation within an ambient temperature range extending from freezing to 120°F/50°C. But because adjacent, less efficient equipment may radiate substantial heat, be sure that the equipment rack is adequately ventilated to keep its internal temperature below the specified maximum ambient.

Panel Indicators and Appointments

FRONT VIEW



- 1 - Phones Output. The following audio signals are reproduced through the headphones:
 - Voice Announcement of DB9000-STC IP Audio Decoder IP address upon startup;
 - Audio signal identical to that of the outputs audio;
- 2 - Power LED Indicator;
- 3 - Status LED Indicator. Blinking frequency of this LED is indication of DB9000-STC state:
 - Fast blinking – in process of connection;
 - Approximately twice per second – data buffering;
 - Approximately once per second – DB9000-STC is connected and operating normally;
- 4 - Left Channel Level LED Indicator. This LED can be in one of the following states:
 - Off - the channel level is within norms;
 - Blinking – indication of low signal level;
 - Constantly lit – indication of high signal level;
- 5 - Right Channel Level LED Indicator. This LED can in one of the following states:
 - Off - the channel level is within norms;
 - Blinking – indication of low signal level;
 - Constantly lit – indication of high signal level;

REAR VIEW

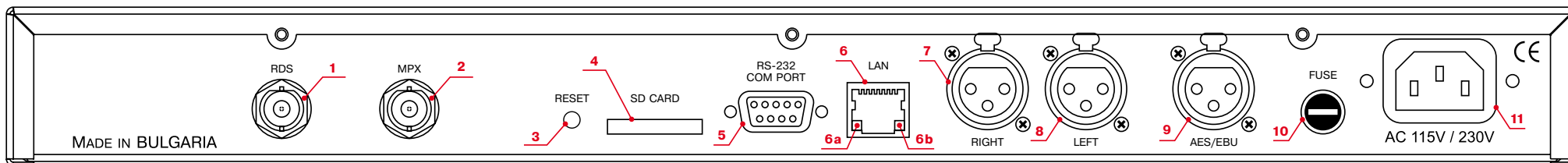

- 1 - RDS only output - BNC, Unbalanced;
- 2 - MPX output - BNC, Unbalanced;
- 3 - Factory Defaults Reset Button;
- 4 - SD Card;
- 5 - RS-232 Serial COM Port - DB-9 Female Connector;
- 6 - LAN Port / Internet Input – RJ-45 Connector;
- 6a - Network Activity LED Indicator (RJ-45 built-in);
- 6b - Network Availability LED Indicator (RJ-45 built-in);
- 7 - Right - Analog Audio Input – Balanced XLR Male;
- 8 - Left - Analog Audio Input – Balanced XLR Male;
- 9 - AES/EBU - Digital Audio Input – Balanced XLR Male;
- 10 - Fuse;
- 11 - Main Power Supply;

Connecting of DB9000-STC

ANALOG AUDIO INPUTS

Using a cable ending with two standard XLR connectors connect the analog signal source to the analog audio inputs of DB9000-STC.

WARNING: Do not exceed maximum input level. This may permanently damage DB9000-STC.

DIGITAL AUDIO INPUT

Using a cable ending with a standard XLR connectors connect the AES/EBU signal source to the digital audio input of DB9000-STC.

NOTE: As only one input can be managed by the encoder at a time, please select the preferred signal source input – either analog or digital one. Selecting the preferred input can be performed under CONFIGURATION menu ([see “Audio Input” on page 29](#)).

LAN PORT

For normal operation it is necessary DB9000-STC to be connected to a local network or Internet by cable with RJ-45 connector.

RS-232 COM PORT

Using standart DB-9 cable connect DB9000-STC to any RS-232 compatible equipment.

Operation

DB9000-STC is controlled through the built-in web server and a standard web browser can be used to monitor its status or make some adjustments. To connect to the device you need to know its IP address and follow the next steps:

- Open a WEB Browser.
- Enter the device IP address in the browser's address field.

NOTE: If the port is different than the default one (80), it is necessary to specify it, e.g. <http://192.168.20.20:9000>

- Press <ENTER>.

If you do not know the IP address you can hear it through the headphones when you turn on the device. The other option to find out the IP address is using UPnP discovery in local networks ([see "UPnP discovery in Local Networks" on page 48](#)).

The web interface consists of the following pages:

- Status
- Configuration
 - General
 - Network
 - Backup Audio
 - COM port
- MPX
 - Stereo Encoder
 - Audio Enhancement
 - RDS Encoder
 - AF List
- Factory Defaults
- Reboot
- Firmware Update

At the top of each page is located the Navigational Menu and underneath, on the left side is the section with relevant information and adjustment fields. There is a kind of help section on the right side, containing brief information about each of the fields on the left.

Hover your mouse over any of the left side fields to bring out a field's description next to the mouse pointer.

The picture below is illustrating STATUS page opened:

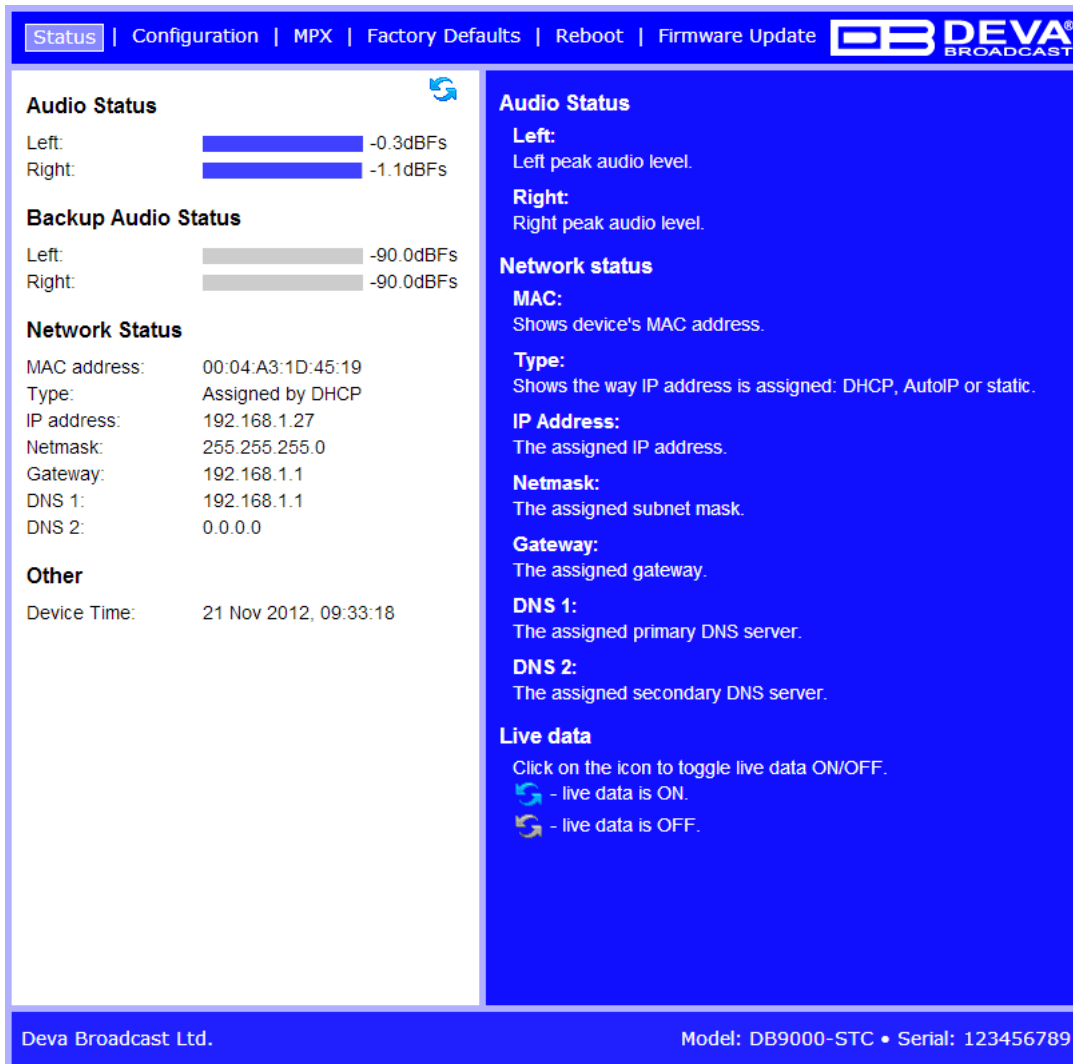

NOTE: As shown on the picture below a Username and Password may be requested if the Access Control is turned on and a page other then STATUS is selected (see “WEB Server Settings” on page 25). Default values are *user* and *pass*.

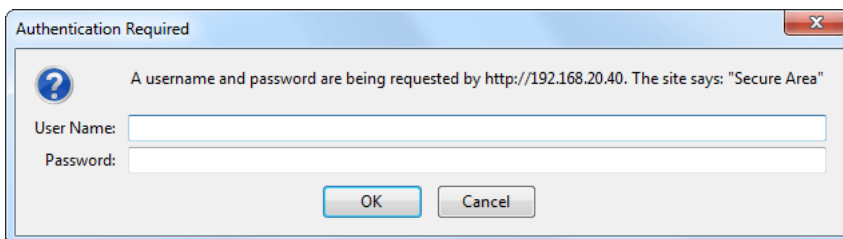

STATUS

On the picture below is shown the page with current device status:

The screenshot displays the 'STATUS' page of a DEVA Broadcast device. The page has a blue header with navigation links: Status, Configuration, MPX, Factory Defaults, Reboot, and Firmware Update. The main content is split into two columns. The left column shows 'Audio Status' with bar graphs for Left (-0.3dBFs) and Right (-1.1dBFs) channels, 'Backup Audio Status' with bar graphs for Left and Right channels at -90.0dBFs, 'Network Status' with details for MAC address (00:04:A3:1D:45:19), Type (Assigned by DHCP), IP address (192.168.1.27), Netmask (255.255.255.0), Gateway (192.168.1.1), DNS 1 (192.168.1.1), and DNS 2 (0.0.0.0), and 'Other' with Device Time (21 Nov 2012, 09:33:18). The right column shows 'Audio Status' with text descriptions for Left and Right peak audio levels, 'Network status' with descriptions for MAC, Type, IP Address, Netmask, Gateway, DNS 1, and DNS 2, and 'Live data' with a toggle icon and text: 'Click on the icon to toggle live data ON/OFF. [ON icon] - live data is ON. [OFF icon] - live data is OFF.' The footer contains 'Deva Broadcast Ltd.' and 'Model: DB9000-STC • Serial: 123456789'.

This page contains information regarding current status of DB9000-STC as follows:

- Audio Status;
- Backup Audio Status;
- Network Status
- Other;

NOTE: Audio Status and Backup Status show the Left and Right channels peak levels which are dynamically updated.

Under *Network Status* are shown MAC address and current IP address, Network mask and Gateway and the method in which they are assigned: Static Allocation or allocated by DHCP server. Shown are also the primary and secondary DNS servers.

Connection Status is the place showing which one of the three available URLs is currently used, device status (connected or disconnected), connection time, stream parameters and name.

Please note that if a compressed stream is used, Sample rate and Bitrate will be taken from the stream. If the stream is in uncompressed format (PCM) then what is displayed for Sample rate and Bitrate is what is set in the Configuration page.

Under *Other* are displayed DB9000-STC date and time.

In the upper right corner is located *LIVE DATA* icon. Clicking on the icon will toggle live data *ON* and *OFF* as follows:



- live data is ON



- live data is OFF.

GENERAL CONFIGURATION

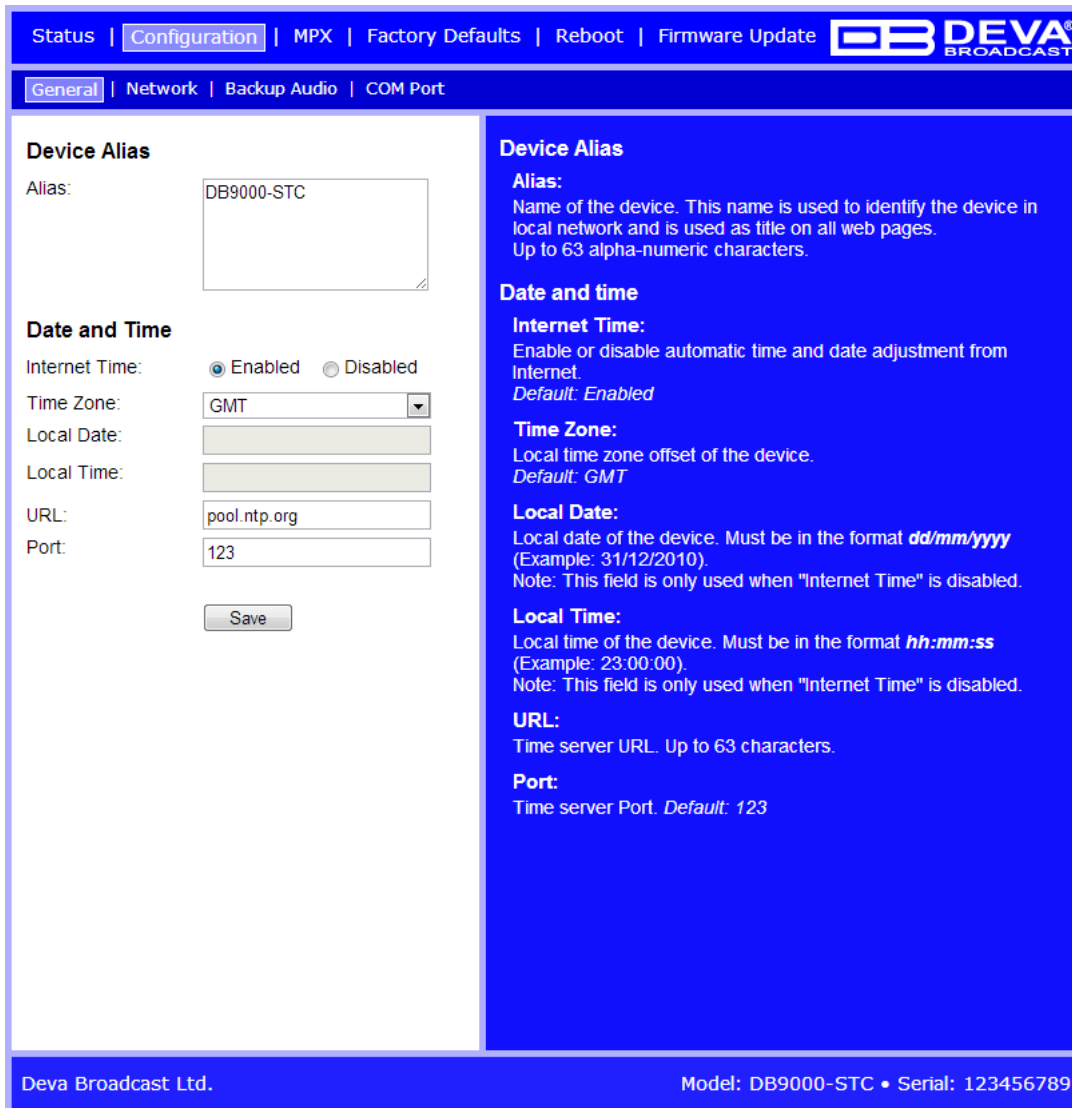

Device Alias

Alias – Name of the device. This name is used to identify the device in a local network and is used as title on all web pages. Up to 63 alpha-numeric characters can be entered.

Date and Time

Internet Time – Enable or disable automatic time synchronization from Internet. Default value: Enabled.

Time Zone – Select local time zone of the device. Default value: GMT.

Local Date – a field where local date is to be entered. This field is only used when Internet Time is disabled. Must be in dd/mm/yyyy format. Example: 31/12/2020.

Local Time – a field where local time is to be entered. This field is only used when Internet Time is disabled. Must be in hh:mm:ss format. Example: 23:10:00.

Applying New Settings

In order new settings to take effect, it is necessary to press the SAVE button. Please keep in mind that some of the new settings can reset DB9000-STC.

NETWORK CONFIGURATION

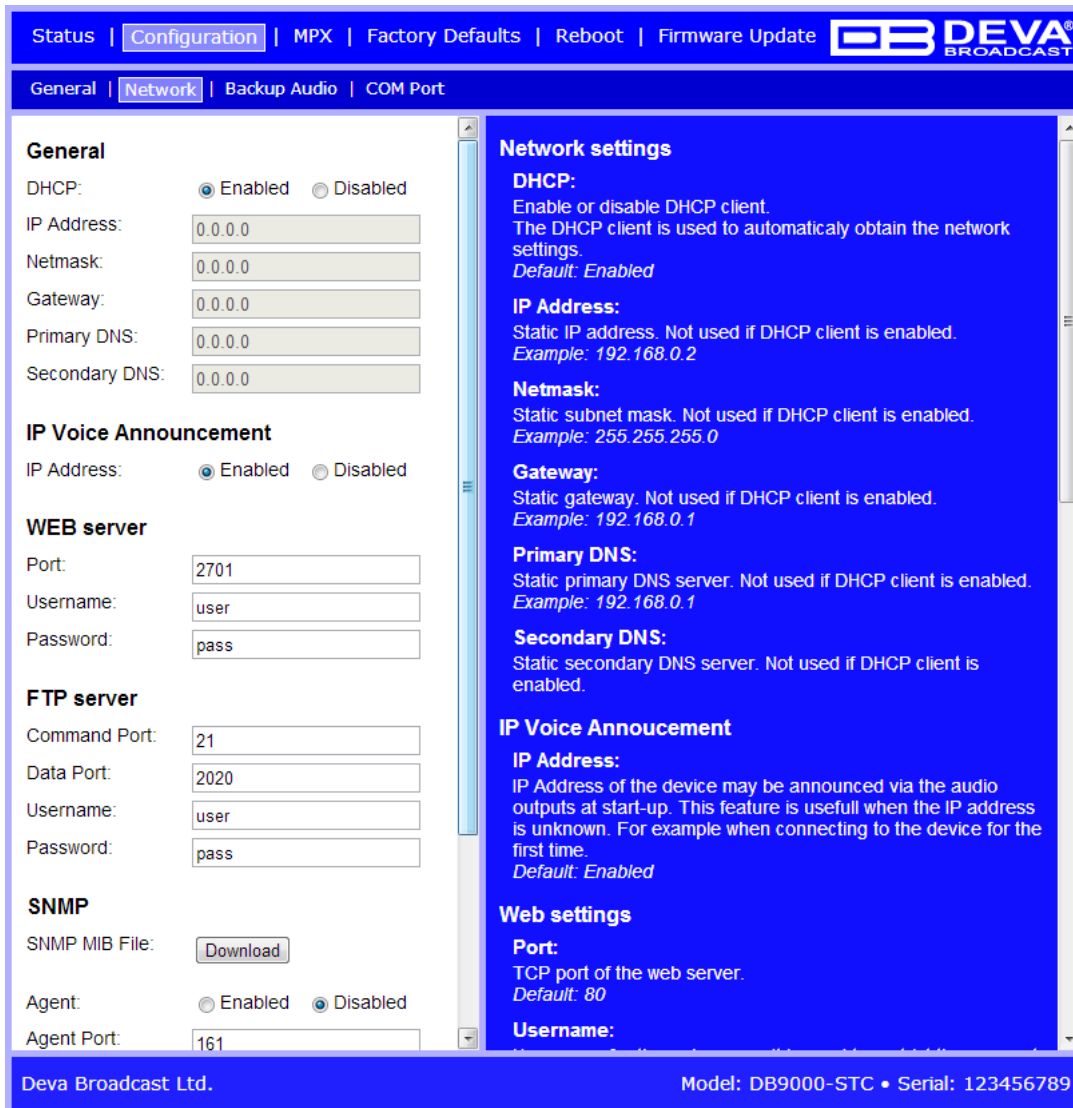

The screenshot shows the 'Configuration' page for a DEVA device, specifically the 'Network' settings. The interface is split into two columns. The left column contains configuration options for various services, and the right column provides detailed descriptions for the network settings.

General

DHCP: Enabled Disabled

IP Address:

Netmask:

Gateway:

Primary DNS:

Secondary DNS:

IP Voice Announcement

IP Address: Enabled Disabled

WEB server

Port:

Username:

Password:

FTP server

Command Port:

Data Port:

Username:

Password:

SNMP

SNMP MIB File:

Agent: Enabled Disabled

Agent Port:

Network settings

DHCP:
 Enable or disable DHCP client.
 The DHCP client is used to automatically obtain the network settings.
 Default: Enabled

IP Address:
 Static IP address. Not used if DHCP client is enabled.
 Example: 192.168.0.2

Netmask:
 Static subnet mask. Not used if DHCP client is enabled.
 Example: 255.255.255.0

Gateway:
 Static gateway. Not used if DHCP client is enabled.
 Example: 192.168.0.1

Primary DNS:
 Static primary DNS server. Not used if DHCP client is enabled.
 Example: 192.168.0.1

Secondary DNS:
 Static secondary DNS server. Not used if DHCP client is enabled.

IP Voice Announcement

IP Address:
 IP Address of the device may be announced via the audio outputs at start-up. This feature is useful when the IP address is unknown. For example when connecting to the device for the first time.
 Default: Enabled

Web settings

Port:
 TCP port of the web server.
 Default: 80

Username:

Deva Broadcast Ltd. Model: DB9000-STC • Serial: 123456789

General Network Settings

DHCP – As DHCP Client is used to automatically obtain the Network Settings it can be enabled or disabled. Default value is Enabled.

IP Address – A field where static IP address is to be entered in case that DHCP client is not used. Example: 192.168.0.2.

Netmask – A field where static subnet mask is to be entered. This parameter is not used if the DHCP Client is enabled. Example for Netmask is: 255.255.255.0.

Gateway – A field where static gateway is to be entered. This parameter is not used if the DHCP Client is enabled. Example for Gateway is: 192.168.0.1.

DNS 1 – A field where Static primary DNS server is to be entered. It is not used if the DHCP Client is enabled. Example: 192.168.0.1

DNS 2 – A field where Static secondary DNS server to be entered. It is not used if the DHCP Client is enabled. Example: 192.168.0.1

IP Voice Announcement

IP Address – Enable or disable voice announcement of DB9000-STC’s IP Address. This feature is useful when the IP address is unknown, for example when it is obtained from the DHCP Server. Default is Enabled.

WEB Server Settings

Port – This is the TCP port of the WEB Server. Default value is 80.

Username – User name for the WEB Server. Default value is *user*.

Password – Password for the WEB Server. Default value is *pass*.

NOTE: Username and Password are used in order to restrict the access to all configuration pages. You can define Username only, Password only or both of them. If both Username and Password are left blank, NO security is used.

FTP Server Settings

Command Port – TCP port where FTP server listens for connection. Default value is 21.

Data Port – TCP port where FTP server transfers data with the client. Default value is 2020.

Username – User name for the FTP Server. Default value is *user*.

Password – Password for the FTP Server. Default value is *pass*.

NOTE: Username and Password are used in order to restrict the access to the storage card and all files on it. You can define Username only, Password only or both of them. If both Username and Password are left blank, NO security is used.

SNMP Settings

SNMP MIB File: Press the Download button to download DB9000-STC SNMP MIB file.

NOTE: The MIB file may change from one firmware revision to the other. Downloading this file from the device ensures that you have the proper MIB file.

Specify Agent ID, Agent Port, Read/Write Communities, Manager IP and Manager Port.

NOTE: Agent ID is used to identify the device among others when a SNMP notification is sent.
Agent - enables/disables SNMP Agent.

Applying New Settings

In order new settings to take effect, it is necessary to press the SAVE button. Please keep in mind that some of the new settings can reset DB9000-STC.

BACKUP AUDIO CONFIGURATION

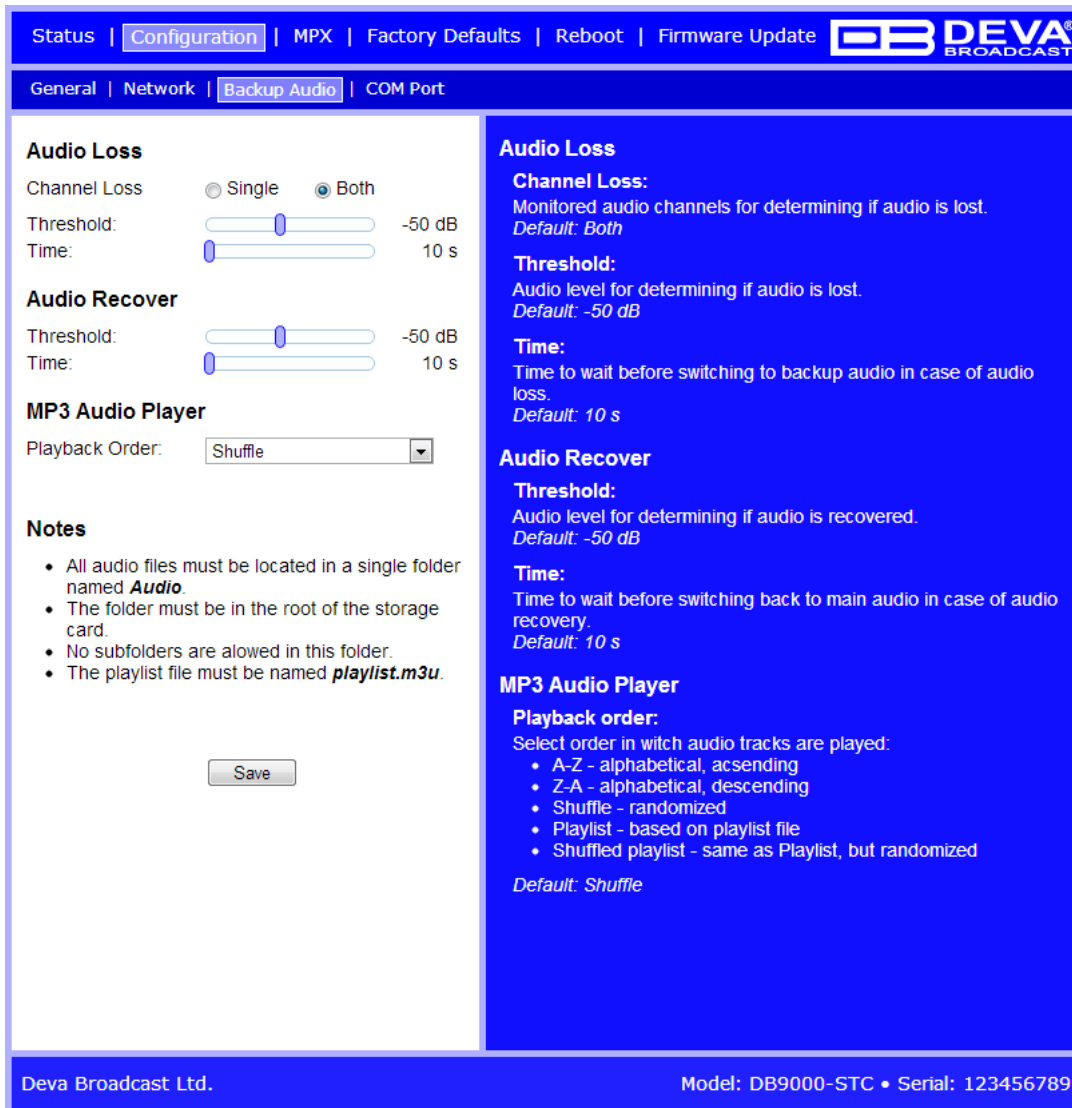

DB9000-STC has built-in backup audio player. It plays tracks from SD Card storage in case of main audio signal loss. These tracks can be preloaded on the SD Card or be uploaded through the built-in FTP server while DB9000-STC is operational.

Audio Loss Settings

Threshold – Audio level threshold for determining if audio signal is lost. Default value is -50 dB.

Time – Time to wait before switching to backup audio in case of audio signal loss. Default value is 10 s.

Audio Recover Settings

Threshold – Audio level threshold for determining if audio signal is present. Default value is -50 dB.

Time – Time to wait before switching back to main audio in case of audio signal recovery. Default value is 10 s.

MP3 Audio Player Settings

Playback Order – Select the order in which tracks are played by the backup player. There are 5 options:

- A-Z – plays all tracks in alphabetical, ascending order;
- Z-A – plays all tracks in alphabetical, descending order;
- Shuffle – plays all tracks in random order;
- Playlist – plays only tracks from the M3U playlist file, in the order they appear in it;
- Shuffled Playlist – plays only tracks from the M3U playlist file, but in random order;

Default value is Shuffle.

NOTES:

- All backup audio files must be located in a single folder named *Audio*;
- The folder must be in the root of the SD Card;
- No subfolders are allowed in this folder;
- The playlist file must be named *playlist.m3u*.

Applying New Settings

In order new settings to take effect, it is necessary to press the SAVE button. Please keep in mind that some of the new settings can reset DB9000-STC.

RS-232 COM PORT CONFIGURATION

Status | Configuration | MPX | Factory Defaults | Reboot | Firmware Update

General | Network | Backup Audio | COM Port

RS-232 Settings

Baudrate: 9600

Ethernet to RS-232 Redirector

Port: 8001

Password:

Save

RS-232 settings

Baudrate:
RS-232 port baudrate.
Default: 9600.

Ethernet to RS-232 Redirector

Port:
Ethernet to RS-232 redirector TCP port.
Default: 8001.

Password:
Password for the Ethernet to RS-232 redirector. It is used to restrict the access to RS-232 from the network. If Password is left blank no security is used. Up to 15 alpha-numeric characters.
Default: (blank).

Deva Broadcast Ltd. Model: DB9000-STC • Serial: 123456789

DB9000-STC also acts as Ethernet to RS-232 redirector. You can connect any RS-232 compatible equipment to DB9000-STC and communicate with it over the Internet.

RS-232 Settings

Baud rate – Select baud rate of the RS-232 COM Port. The external equipment must be configured to the same baud rate. Default value is 9600.

Ethernet to RS-232 Redirector

Port – a field where TCP port of the Ethernet to RS-232 redirector is to be entered. This is the TCP port used to communicate with any external device connected to the RS-232 COM Port. Default value is 8001.

Password – Password for the RS-232 server. These are the first symbols that must be sent to authenticate to the Ethernet to RS-232 redirector, otherwise the connection is dropped. If left blank NO security is used. Default value is *blank (empty)*.

STEREO ENCODER CONFIGURATION



The screenshot shows the 'Stereo Encoder' configuration page. The top navigation bar includes 'Status', 'Configuration', 'MPX', 'Factory Defaults', 'Reboot', and 'Firmware Update'. The left pane contains the following settings:

- General:** Stereo Mode (Stereo selected), Emphasis (50µs selected).
- Audio Input:** Input (Digital selected), A/D amplifier gain (0.0 dB).
- Injection Levels:** Pilot Tone (10.0%), RDS (5.0%).
- Phase Adjustments:** Pilot Tone (0°), L-R Subcarrier (0°), RDS Subcarrier (0°).
- MPX Limiter:** Enable (Disabled selected), Threshold (+100%), Processing (Soft).
- Output levels:** MPX output (0.0 dBu), RDS output (0.0 dBu).

The right pane provides detailed help text for each section, such as: 'Stereo mode: Select "Stereo" or "Mono". Note: Only the Left audio channel is used in "Mono" mode. Default: Stereo.'

General Settings

Stereo Mode – Switch between Stereo and Mono Mode for MPX signal. Mono Mode disables the 38 kHz sub-carrier.

Emphasis – The pre-emphasis operation consists of amplifying the high audio frequency levels as compared to the low audio frequencies. The purpose of this is to reduce the signal/noise ratio in a proportion of 10 to 15dB by performing the inverse operation at the receiving level. There is 50µS for Europe and 75µS for USA options available.

Audio Input

Input - select analog or digital input to be used

A/D Amplifier Gain - Analog input gain in the range from -6 to +18 dB. Default level is 0 dB

Injection Levels

Pilot Tone – Here can be adjusted modulation level of the pilot tone as a component of the MPX signal.

RDS – Modulation level of the RDS can be adjusted from 0 to 12% from the overall MPX signal level.

Phase Adjustment

Phase of the Pilot Tone, L-R sub-carrier (38 kHz) and RDS sub-carrier (57 kHz) are factory adjusted. Additional adjustments can be made by the user providing more flexibility in DB9000-STC settings.

MPX Limiter

Enable – Enable or Disable the MPX Limiter.

Preset – There are three factory and three user configurable presets available. Users can set their own Limiter presets by changing following parameters:

- *Attack time* – the period when the limiter is decreasing gain to reach the level that is determined by the ratio.

- *Release time* – the period when the limiter is increasing gain to the level determined by the ratio, once the level has fallen below the threshold.

- *Averaging time* – the period between each of the input samples of the limiter.

- *Threshold* – the input level above which the signal is reduced.

- *Ratio* – determines the input/output ratio for signals above the threshold.

Output Levels

MPX output – Select output level of the MPX signal. It can be adjusted in the range -72 to +12 dBu in 1.5 dB steps. Default value is +6 dBu.

RDS output – Select output level of the RSD signal. It can be adjusted in the range -72 to +6 dBu in 1.5 dB steps. Default value is 0 dBu.

Applying New Settings

In order new settings to take effect, it is necessary to press the SAVE button. Please keep in mind that some of the new settings can reset DB9000-STC.

AUDIO ENHANCEMENT CONFIGURATION

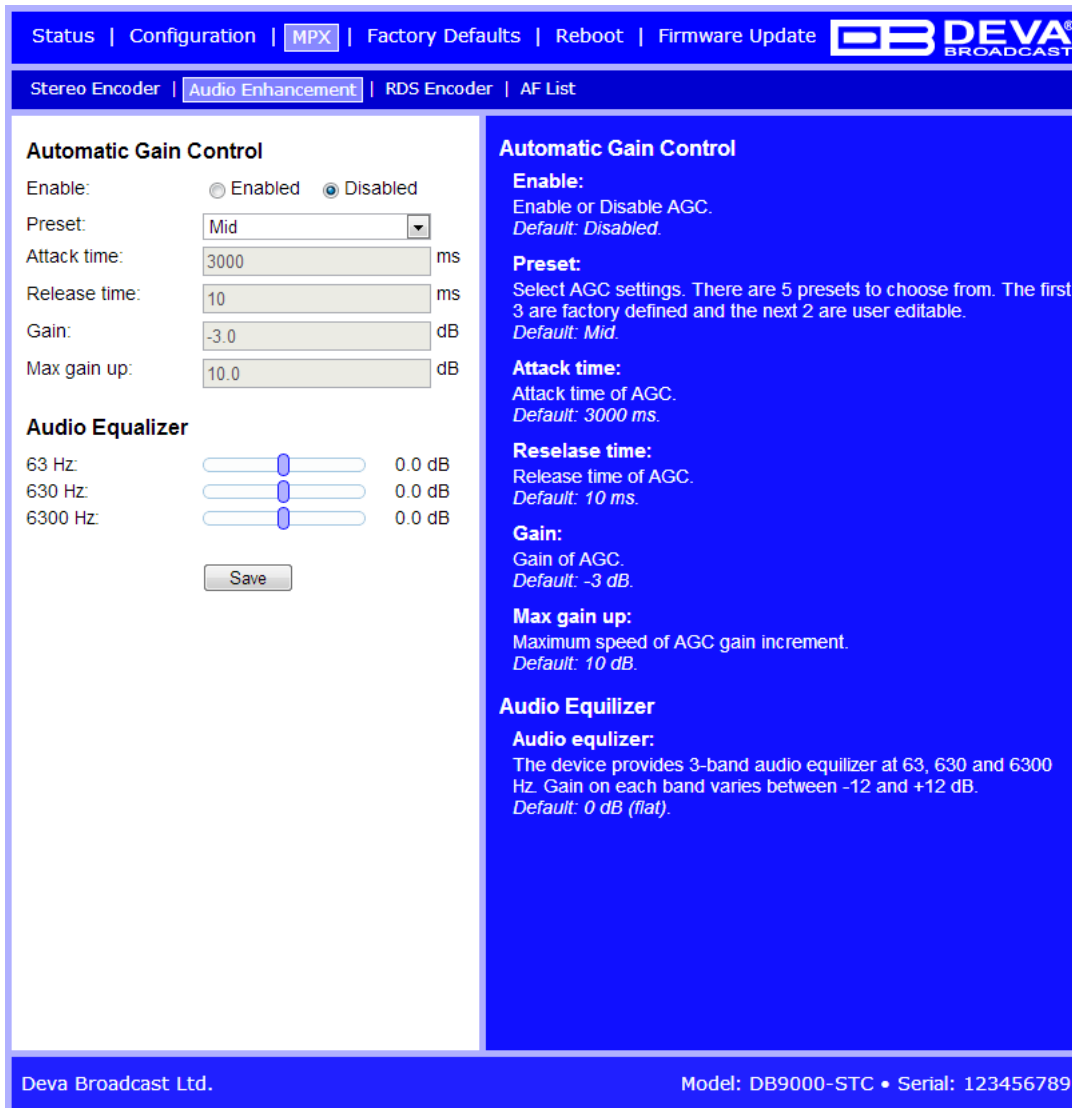

Automatic Gain Control

Enable: Enabled Disabled

Preset:

Attack time: ms

Release time: ms

Gain: dB

Max gain up: dB

Audio Equalizer

63 Hz: dB

630 Hz: dB

6300 Hz: dB

Automatic Gain Control

Enable:
 Enable or Disable AGC.
 Default: Disabled.

Preset:
 Select AGC settings. There are 5 presets to choose from. The first 3 are factory defined and the next 2 are user editable.
 Default: Mid.

Attack time:
 Attack time of AGC.
 Default: 3000 ms.

Release time:
 Release time of AGC.
 Default: 10 ms.

Gain:
 Gain of AGC.
 Default: -3 dB.

Max gain up:
 Maximum speed of AGC gain increment.
 Default: 10 dB.

Audio Equalizer

Audio equalizer:
 The device provides 3-band audio equalizer at 63, 630 and 6300 Hz. Gain on each band varies between -12 and +12 dB.
 Default: 0 dB (flat).

Deva Broadcast Ltd. Model: DB9000-STC • Serial: 123456789

Automatic Gain Control Settings

Enable – Enable or Disable the Automatic Gain Control.

Preset – There are three factory and two user configurable presets available. Users can set their own AGC presets changing the following parameters:

- *Attack time* – the period when the AGC is increasing gain to reach the ‘Gain’ level, when the input level is below the level set in ‘Gain’.

- *Release time* – the period when the AGC is decreasing gain to the level determined by the ‘Gain’, once the level has exceeded the level set in ‘Gain’.

- *Gain* – the input level above which the signal increases its gain. Note that applied gain is only positive.

- *Max gain up* – To avoid excessive gains that can amplify the noise in a quiet program, ‘Max gain up’ must be set according to the program.

Audio Equalizer Settings

63 Hz – gain -12dB to +12dB.

630 Hz – gain -12dB to +12dB.

6300 Hz – gain -12dB to +12dB.

NOTE: Applied equalizer gain must be set according to the level of specified frequency and overall level of this frequency. To avoid audio distortion the overall level of this frequency must not exceed 0dB.

Applying New Settings

In order new settings to take effect, it is necessary to press the SAVE button. Please keep in mind that some of the new settings can reset DB9000-STC.

RDS ENCODER CONFIGURATION

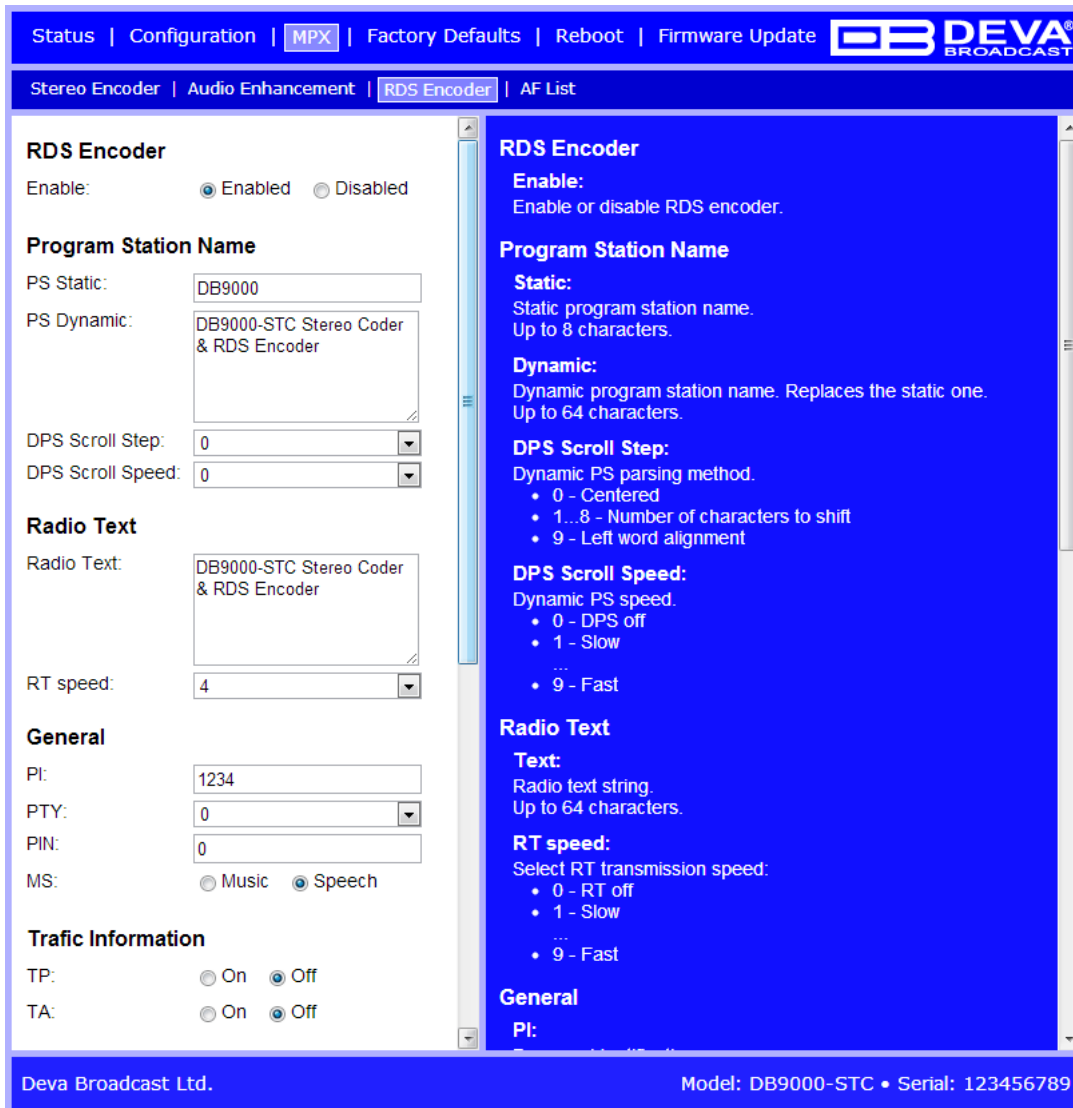

The screenshot displays the RDS Encoder configuration page. At the top, there are navigation tabs: Status, Configuration, MPX, Factory Defaults, Reboot, and Firmware Update. Below these are sub-tabs: Stereo Encoder, Audio Enhancement, RDS Encoder (selected), and AF List. The main content area is divided into two sections. The left section contains the configuration fields, and the right section contains the help text for the selected 'RDS Encoder' tab. The footer of the interface includes the company name 'Deva Broadcast Ltd.' and the device model and serial number 'Model: DB9000-STC • Serial: 123456789'.

RDS Encoder Settings

Enable – General Enable or Disable RDS Encoder.

Program Station Name Settings

PS Static – The 8-character PS field is for the “street name” of the station. This will appear on the radio faceplate whenever a dynamic, scrolling – PS message is not being transmitted.

PS Dynamic – We provide Dynamic PS in block mode because of our concern over distracted car drivers. Viewing a message in the block mode (complete words or groups of words), a driver must pay close attention to the radio display, or risk missing part of the message. Although the message may be repeated over and over, the driver may tune in at the end of a song, and in finding out who sang the number could rear-end the car in front.

Dynamic PS ‘marches’ the message across the display screen one character at a time. The message requires a much longer transmission time in this mode, but a glance at the radio display a few seconds still allows the driver to get the full message without missing words.

DPS Scroll Step – DPS Scroll Step is used in the “block” mode of message transmission, the more popular ‘grouped-word’ method. Once ‘DPS Scroll Step’ options are set, this encoder function is valid for any scrolling-PS message, whether it is entered into the static DPS register,

or received as ASCII text from station automation. Very short words are sent together in groups. For instance, THIS IS constitutes seven characters that can be sent as a group. The same would hold true for OF THE or NOW HERE. Longer words, up to and including 8 characters, are sent individually: WARNING or DOUGHNUT or BICYCLE. The device can either center words that are sent individually on the radio display or left-justify them. This will be covered along with the function of the 'DPS Scroll Step'. Words that exceed the available 8 characters are 'sidestepped' through two or more consecutive displays. Examples: EMERGENC followed by MERGENCY, or SUPERMAR followed by UPERMARK and PERMARKE and ERMARKET. This method of splitting words gives a good sense of continuity and readability.

Setting 'DPS Scroll Step' to 1 will scroll the message one character at a time, as described. Other numbers also safe-scroll the message, but at 2, 3, 4, and up to 8 characters at a time. Selecting 9 will parse, as described, but text will be left-justified rather than centered on the display. 2 through 8 may be useful in some special RDS applications, but 0 and 1 are the primary 'DPS Scroll Step' selections. To recap: 0 will enable the more-popular, centered-auto-parsed block mode and 1 the Dynamic PS, letter-by-letter option.

DPS Scroll Speed – The speed of dynamic PS messaging is set here, or dynamic PS messaging can be turned off entirely. When OFF is selected, the dynamic PS message remains in the non-volatile encoder memory, but only the 8-character default static "street name" typed into the PS field will be displayed on the receiver faceplate. Setting the speed at 1 will result in the slowest refresh rate of the 'block' message, or slowest Safe Scrolling. 9 is the fastest speed, but many RDS radios display gibberish at high speed settings. The display should be stable with any radio at a speed setting of 7 or lower.

Radio Text Settings

Radio Text – This is a 64-character block of plain text that the listener can select for visual display on the faceplate of the radio by pressing an INFO button on the receiver. This function is not available on many automobile radios for safety reasons, which has precipitated the frowned-upon practice of scrolling the PS field instead. Most radios have limited alphanumeric display capability, so the 64 characters of Radio Text march across the front panel, much akin those annoying LED advertising signs found in airport buses or fast food emporia. Like the Dynamic PS implementation, Radio Text can announce song titles and performers, run special promotions or contests, or broadcast sponsors' messages.

RT Speed – The Radio Text update rate is programmed by setting RT Speed =n , with n a number between 1 and 9, corresponding to a refresh rate between slow and fast, respectively. Keeping the throughput tradeoff in mind, unless Radio Text is being used for contests or for other quasi-dynamic activities, it is best to use a lower number. A rate of 1, 2 or 3 will make little difference in the speed of other RDS functions.

NOTE: Radio Text can be turned off entirely by setting: RT Speed =0. A zero value in this field turns the Radio Text message off, but does not delete any saved message from memory.

General Settings

PI – Program Identification: This block of data identifies the broadcast station with a hexadecimal numerical code, which becomes the "digital signature" of the station. The code is assigned by the broadcasting authority in most countries, but in the US it is calculated from a numerical encoding of station call letters. The receiver processes the PI code to assist automatic tuning features (station memories), and to prevent false switching to alternative frequencies that might be shared by broadcasters in nearby regions.

PTY – Program Type: The PTY data flag identifies the station format from a collection of pre-defined categories. Many RDS receivers are able to seek the listener's preferred format automatically. This means that a car radio can switch from a fading station to a stronger one

that carries the same variety of music, though not the very same program, as provided by AF switching. The PTY function of RDS helps a broadcaster catch ‘transient audience’ share. Under some programming circumstances, the PTY identifier may be made ‘dynamic,’ changing between categories for a station that “dayparts” (changes its format for specific time periods). The PTY code is not meant to change from song to song or to accommodate a top-of-the-hour newscast, however.

M/S – Music / Speech Switch: This flag simply indicates whether music or speech is the primary broadcast programming. The purpose of this function is not well explained in the respective Standards, hence it comes as no surprise that it is not widely used.

Traffic Information

TP – Traffic Program Identification: The TP flag identifies the station as one that routinely broadcasts traffic bulletins for motorists as part of its normal, everyday programming. When the TP flag is displayed on the receiver faceplate, the radio is searching for traffic announcements. The radio keeps track of TP stations offering this service to speed up the search-and-switch process.

TA – Traffic Announcement: This is a temporary flag added to the RDS data stream only as a traffic bulletin is being aired. Some RDS car radios can be set to search for traffic bulletins among various TP stations (see TP) while tuned to a listener’s preferred program, or even while playing a tape or CD. As soon as any TP station broadcasts a traffic bulletin, the receiver temporarily switches-over to receive it. When the bulletin is finished, the receiver switches back to the original program, tape or CD.

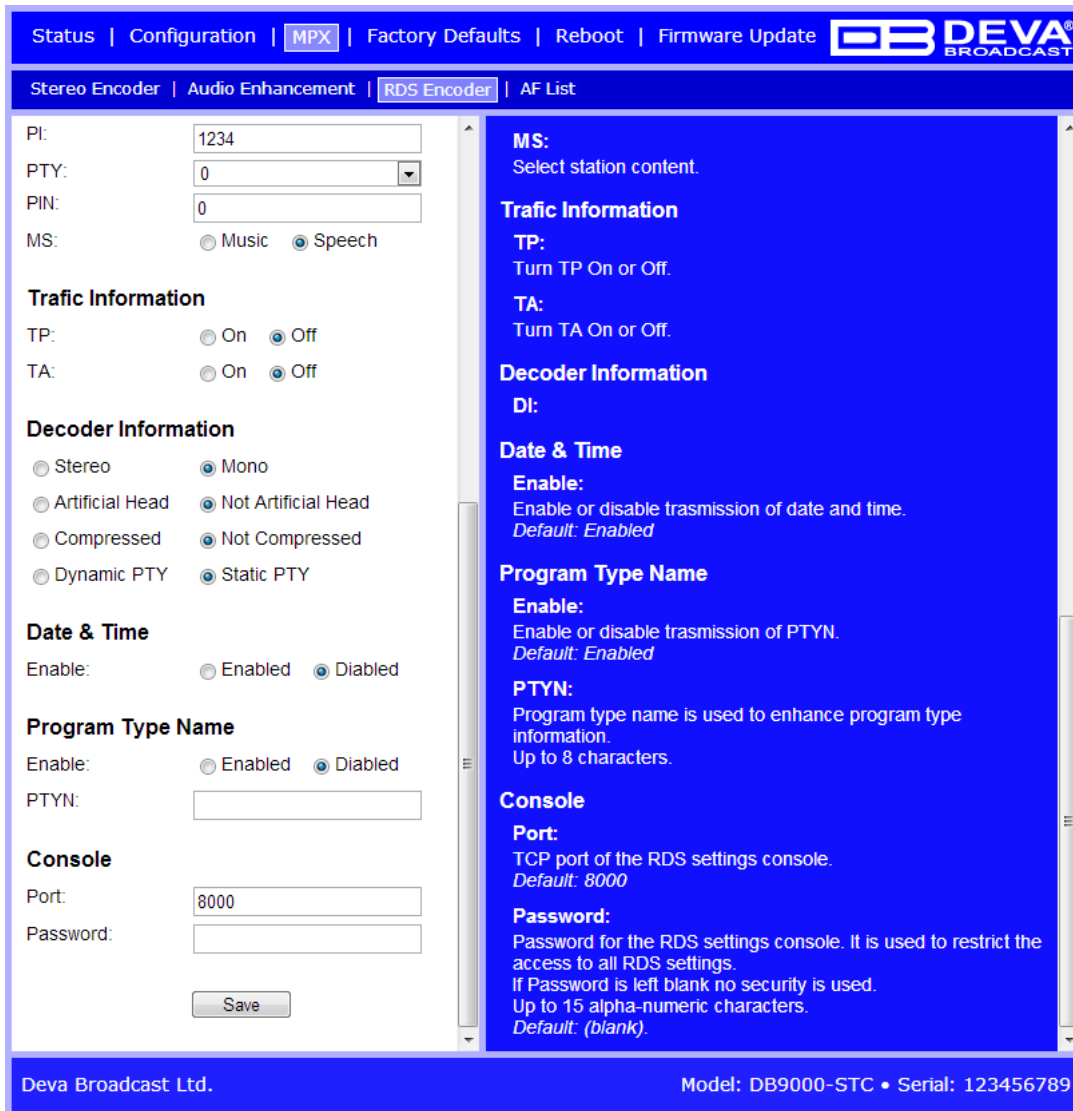

The screenshot shows the 'RDS Encoder' configuration page. The left sidebar contains the following settings:

- PI: 1234
- PTY: 0
- PIN: 0
- MS: Music Speech
- Traffic Information**
 - TP: On Off
 - TA: On Off
- Decoder Information**
 - Stereo Mono
 - Artificial Head Not Artificial Head
 - Compressed Not Compressed
 - Dynamic PTY Static PTY
- Date & Time**
 - Enable: Enabled Disabled
- Program Type Name**
 - Enable: Enabled Disabled
 - PTYN:
- Console**
 - Port: 8000
 - Password:

A 'Save' button is located at the bottom of the left panel. The right panel provides detailed information for several settings:

- MS:** Select station content.
- Traffic Information**
 - TP:** Turn TP On or Off.
 - TA:** Turn TA On or Off.
- Decoder Information**
 - DI:**
- Date & Time**
 - Enable:** Enable or disable trasmission of date and time. *Default: Enabled*
- Program Type Name**
 - Enable:** Enable or disable trasmission of PTYN. *Default: Enabled*
 - PTYN:** Program type name is used to enhance program type information. Up to 8 characters.
- Console**
 - Port:** TCP port of the RDS settings console. *Default: 8000*
 - Password:** Password for the RDS settings console. It is used to restrict the access to all RDS settings. If Password is left blank no security is used. Up to 15 alpha-numeric characters. *Default: (blank)*

At the bottom of the interface, it says 'Deva Broadcast Ltd.' and 'Model: DB9000-STC • Serial: 123456789'.

Decoder Information

DI – Decoder Information: This is one of several ‘flags’ that convey yes/no or other very basic data. This particular flag tells the receiver whether the broadcast is monaural, or is being transmitted in any of several methods of stereo or binaural broadcasting. As many as 16 encoding options may be accommodated! This is a rather esoteric function and, thus far, remains unused both in Europe and in the US.

Date & Time Settings

Enable – Enable/Disable type 4A Group Transmission.

Program Type Name Settings

Enable – Enable/Disable type 10A Group Transmission. This group allows further description of the current Program Type.

PTYN – Program Type Name (PTYN) (for display) is transmitted as 8-bit characters. PTYN must only be used to enhance Program Type information and it must not be used for sequential information.

Console Settings

Port – a field where TCP port of the RDS console is to be entered. This console is used to edit RDS settings in real time. Default value is 8000.

Password – Password for the RDS console. These are the first symbols that must be sent to authenticate to the RDS console, otherwise the connection is dropped. If left blank NO security is used. Default value is *blank (empty)*.

NOTE: For more information about the RDS console see chapter [“RDS Console”](#).

Applying New Settings

In order new settings to take effect, it is necessary to press the SAVE button. Please keep in mind that some of the new settings can reset DB9000-STC.

AF LIST CONFIGURATION

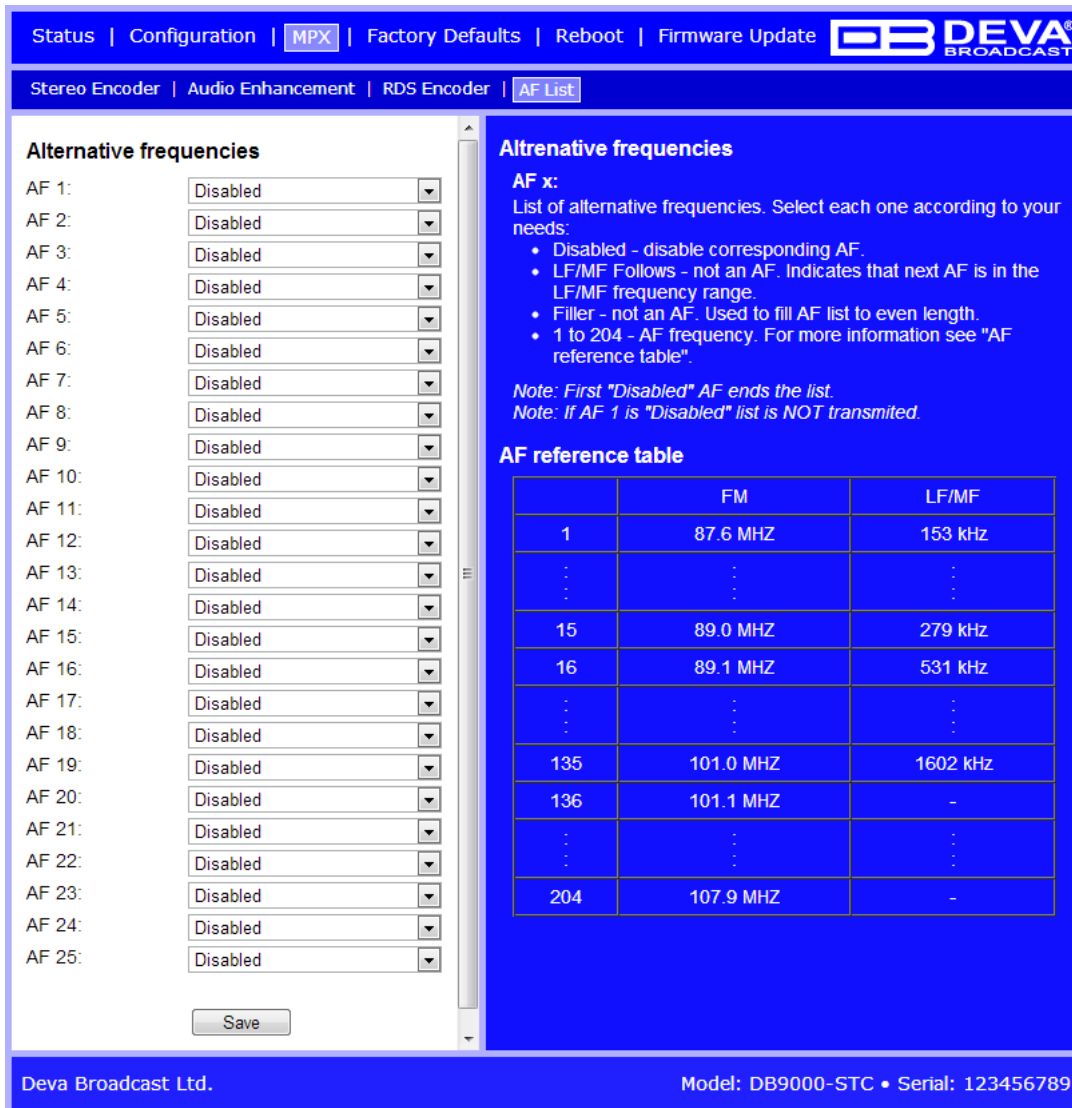

Status | Configuration | **MPX** | Factory Defaults | Reboot | Firmware Update 

Stereo Encoder | Audio Enhancement | RDS Encoder | **AF List**

Alternative frequencies

AF 1: Disabled
 AF 2: Disabled
 AF 3: Disabled
 AF 4: Disabled
 AF 5: Disabled
 AF 6: Disabled
 AF 7: Disabled
 AF 8: Disabled
 AF 9: Disabled
 AF 10: Disabled
 AF 11: Disabled
 AF 12: Disabled
 AF 13: Disabled
 AF 14: Disabled
 AF 15: Disabled
 AF 16: Disabled
 AF 17: Disabled
 AF 18: Disabled
 AF 19: Disabled
 AF 20: Disabled
 AF 21: Disabled
 AF 22: Disabled
 AF 23: Disabled
 AF 24: Disabled
 AF 25: Disabled

Save

Altrenative frequencies

AF x:
 List of alternative frequencies. Select each one according to your needs:

- Disabled - disable corresponding AF.
- LF/MF Follows - not an AF. Indicates that next AF is in the LF/MF frequency range.
- Filler - not an AF. Used to fill AF list to even length.
- 1 to 204 - AF frequency. For more information see "AF reference table".

Note: First "Disabled" AF ends the list.
Note: If AF 1 is "Disabled" list is NOT transmitted.

AF reference table

	FM	LF/MF
1	87.6 MHz	153 kHz
⋮	⋮	⋮
15	89.0 MHz	279 kHz
16	89.1 MHz	531 kHz
⋮	⋮	⋮
135	101.0 MHz	1602 kHz
136	101.1 MHz	-
⋮	⋮	⋮
204	107.9 MHz	-

Deva Broadcast Ltd. Model: DB9000-STC • Serial: 123456789

On the above picture is displayed Alternative Frequencies List Configuration Page, consisting of 25 AF settings:

AF xx – Select alternative frequency of current program. You can choose from 207 standard AF list options as defined in the RDS/RBDS standard.

- The first option is Disabled, meaning this AF is not used. The first disabled AF ends the AF list;

- The second option is LW/MW Follows. This is not an AF, but a special symbol. It means the next AF in the list is in the LW/MW frequency range.

- The third option is Filler. This is not an AF, but a special symbol used to pad the AF list to even length;

- Each of the rest of the options corresponds to a specific FM or LW/MW frequency.

FACTORY DEFAULTS SETTINGS



On the above picture is shown the Factory Defaults page. Restoring DB9000-STC to its Factory Defaults can be done by following the next steps:

- Press the “Restore” button.
- A new window as the one shown below will appear:

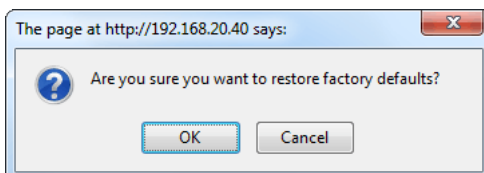

- Confirm that you want to restore factory defaults.
- Wait for the process to complete.

NOTE: All the settings will be restored to their factory defaults except the Network Settings, which will remain the same.

Upon completion of the process DB9000-STC settings will have the following values:

General Default Settings

Device Alias:

- Alias: DB9000-STC

Date and Time:

- Internet Time: Enabled
- Time Zone: GMT

Network Default Settings

General: All the General Network Settings will remain unchanged.

IP Voice Announcement:

- IP Address: Enabled

WEB Server Settings: All the WEB server Settings will remain unchanged.

FTP Server Settings:

- Command Port: 21
- Data: 2020
- Username: user
- Password: pass

SNMP Settings:

- Agent : Disabled
- Agent Port: 161
- Community: DEVA9000
- Manager IP: 0.0.0.0
- Manager Port: 162
- Agent ID: 0

Backup Audio Default Settings

Audio Loss Settings:

- Threshold: -50 dBFs
- Time: 10 s

Audio Recover Settings:

- Threshold: -50 dBFs
- Time: 10 s

Backup Player Settings:

- Playback: Shuffle

COM Port Default Settings

RS-232 Settings:

- Baud rate: 9600

Ethernet to RS-232 Redirector:

- Port: 8001
- Password: blank (empty)

Stereo Encoder Default Settings

General Settings :

- Stereo Mode: Stereo
- Emphasis: 50 μ S

Injection Levels:

- Pilot Tone: 10 %
- RDS: 5 %

Phase Adjustment: All phase are at 0°.

MPX Limiter:

- Enable: Disabled
- Preset: Mid
- Attack time: 100 ms
- Release time: 500 ms
- Averaging: 10 ms
- Threshold: -15 dB
- Ratio: 4:1

Output Levels:

- MPX output: +6 dBu
- RDS output: 0 dBu

Audio Enhancement Default Settings

Automatic Gain Control Settings:

- Enable: Disabled
- Preset: Mid
- Attack time: 3000 ms
- Release time: 10 ms
- Gain: -3 dB
- Max gain up: 10 dB

Audio Equalizer Settings:

- 63 Hz: 0dB
- 630 Hz: 0dB
- 6300 Hz: 0dB

RDS Encoder Default Settings

RDS Encoder Settings:

- Enable: Enabled

Program Station Name Settings:

- PS Static: DB9000
- PS Dynamic: DB9000-STC Stereo Coder & RDS Encoder
- DPS Scroll Step: 0 – centered
- DPS Scroll Speed: 0 – DPS off

Radio Text Settings:

- Radio Text: DB9000-STC Stereo Coder & RDS Encoder
- RT Speed: 4

General Settings:

- PI: 1234
- PTY: 0
- M/S: Speech

Traffic Information:

- TP: Off
- TA: Off

Decoder Information:

- DI: Mono, Not Artificial Head, Not Compressed, Static PTY

Date & Time Settings:

- Enable: Disabled

Program Type Name Settings:

- Enable: Disabled
- PTYN: blank field

Console Settings:

- Port: 8000
- Password: blank (empty)

AF List Default Settings

All AFs are diasabled.

HARDWARE RESET

This process will fully restore DB9000-STC to its Factory Defaults, including the Network settings. Hardware Reset can be done by following the next steps:

- Disconnect the power supply cable from the unit.
- Locate the RESET button on Rear panel.
- Press and hold the RESET button.
- Connect the power supply cable to the unit.
- Keep the RESET button pressed until the POWER led starts blinking.
- Release the RESET button.
- Wait for DB9000-STC to reboot with the factory default settings.

Upon completion of the process DB9000-STC settings will have the following values:

Network Default Settings

- DHCP: enabled

WEB Server Default Settings

- Port: 80
- Username: user
- Password: pass

All other settings will have the factory default values described in chapter [“Factory Defaults Settings”](#).

NOTE: After the process completes the DHCP Client is enabled. The DB9000-STC will obtain IP Address from DHCP server shortly.

ATTENTION: Please note that the WEB Server’s Port, Username and Password will be changed, so it is possible the page not to be loaded after restoring factory defaults. You may be asked to re-enter the encoder’s address and/or username and password.

REBOOTING



On the above picture is shown the Reboot page. Rebooting of DB9000-STC can be done by following the next steps:

- Press the “Reboot” button.
- The following dialog warning window will appear:

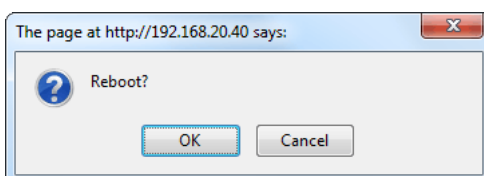

- Confirm that you want to reboot the device.
- Wait for the process to complete.

FIRMWARE UPDATE

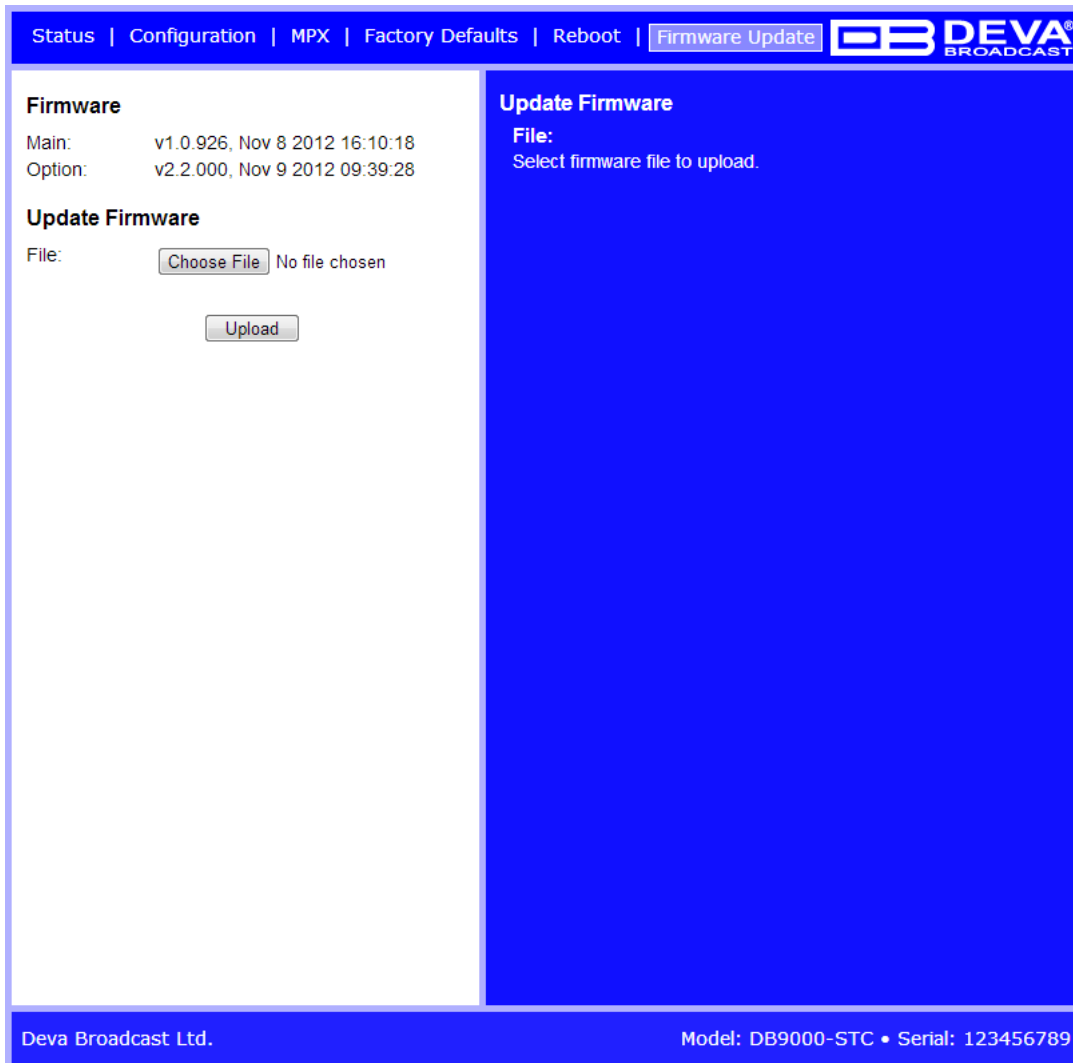

On the above picture is shown the Firmware Update page. To update the device firmware, please follow the next steps:

- Select the new firmware file.
- Press the “Upload” button.
- The following dialog window will appear:

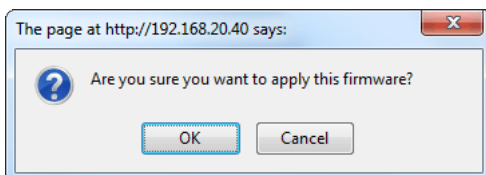

- Wait for the process to complete.

RDS Console

CONNECTING TO THE RDS CONSOLE

The RDS Console is used to edit RDS settings in real time. For example it can be used by automation software.

To use the console do the following steps:

1. Connect to the TCP port of the RDS console with a terminal program or an automation software.
2. Wait to receive the welcome message.
3. Enter the password, if used.
4. Proceed with entering commands.

RDS CONSOLE SYNTAX

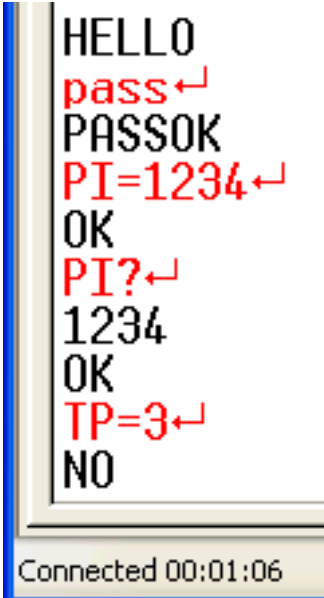

```
HELLO
pass↵
PASSOK
PI=1234↵
OK
PI?↵
1234
OK
TP=3↵
NO
Connected 00:01:06
```

The picture above is a sample RDS console conversation. The red text represents user input and black text represents the console's responses. The symbol '↵' represent the Enter key on the keyboard.

The first row is the welcome message from the RDS console. Next the user types in the password (in this case 'pass'), followed by Enter. The third row is the response meaning that the password is accepted and user may proceed with commands.

The fourth row is a 'set' command. These types of commands are used to set new value to RDS parameters. In the example above 'PI' is the Program Identification command, '=' (equal sign) means set new value and '1234' is the new value. The Enter key represents command's end and signals the RDS console to execute the command. The fifth row is a positive response from the RDS console. It means the command is accepted and executed successfully.

The sixth row is a 'get' command. These types of commands are used to return the current value of RDS parameters. In the example above 'PI' is the Program Identification command, '?' (question mark) means return PI's value. The RDS console responds with the current value (in this case '1234') and positive response on the next row.

The ninth row is again a 'set' command. In this case: Set Traffic Program to 3. The response is negative because the parameter TP can only have value 0 or 1.

LIST OF AVAILABLE RDS CONSOLE COMMANDS AND RESPONSES

PARAMETER	COMMAND	DATA ENTRY
Program Identification	PI	4 digit HEX number (station “digital address”)
Program Service Name	PS	8 (max) ASCII characters (station “street name”)
Dynamic PS	DPS	64 (max) ASCII characters (for messaging in PS field)
Dynamic PS Speed	DPSS	0 to 9 (0 = Off, 1 = slow, 9 = fastest)
Dynamic PS Method	PARSE	0 through 9 (0 = parsed, centered; 1-8 Safe Scrolling; 9 = parsed, left)
Program Type	PTY	1 or 2 digit number (describes station format)
Traffic Program	TP	0 or 1 (0 = no, 1 = yes)
Traffic Alert	TA	0 or 1 (0 = flag off, 1 = flag on)
Alternative Frequencies <i>xx denotes AF number between 1 and 25</i>	AFxx	0 to 204 (0 = blank; 1 to 204 = “channel” in 100 kHz increments, 87.6 MHz to 107.9 MHz)
Decoder Information	DI	1 digit HEX number
M/S	MS	0 or 1 (0 = speech-only, 1 = music)
RadioText	TEXT	64 (max) ASCII characters
RadioText Speed	DRTS	0 to 9 (0 = Radiotext off; 1 to 9 = update rate, slow to fast)
Command Echo	ECHO	0 or 1 (0 = echo off, 1 = echo on)

SPECIAL COMMAND	MEANING
=	Set parameter value. Following a parameter command sets new value to that parameter; e.g.: PI=1234
?	Get parameter value. Following a parameter command returns status of encoder memory for that parameter; e.g.: AF3?
??	Returns all data in encoder memory.
INIT	Initializes the encoder to all factory defaults.

RESPONSE	MEANING
HELLO	Welcome message when connection to the console is established. If security is enabled proceed with entering the password. Otherwise proceed with commands.
PASSOK	Password accepted, may proceed with commands.
PASSFAIL	Wrong password. Connection is dropped immediately.
OK	Command received by encoder properly formatted and understood.
NO	Command properly formatted but data not understood.
BYE	Console has been inactive for more than 30 minutes and the connection will be dropped. User needs to connect again to enter more commands.
(NO RESPONSE)	Data sent is ignored by DB9000-STC.

UPnP discovery in Local Networks

DB9000-STC implements UPnP which lets you easily find it in your local network. For this purpose your system should have UPnP enabled ([see “UPnP Activation” on page 49](#)). To discover the device follow the next steps:

- Connect the device to the local network.
- Open “My Network Places” on your computer.
- Find the decoder’s icon.
- Double click it to open the DB9000-STC web interface.

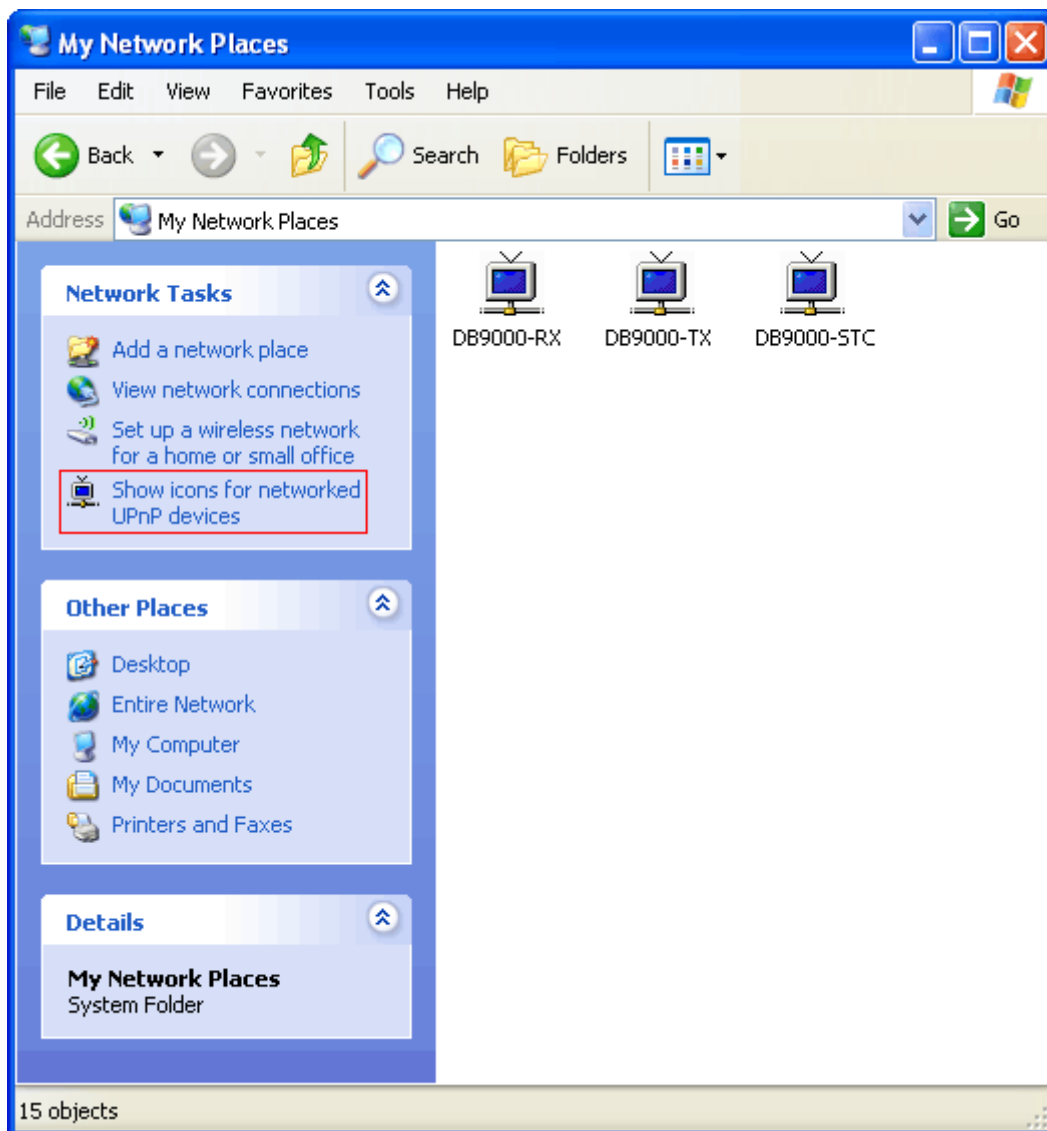

UPnP Activation

NOTE: The following explanations apply to Windows XP SP2 or SP3! If you use another operating system, please contact your system administrator.

Open “My Network Places”. If you have the caption displayed in the picture below, click on it. Then click “Yes” and wait for the process to complete. Now you should see the device. If you still have troubles finding the device, please see

<http://support.microsoft.com/kb/941206> or contact your system administrator.

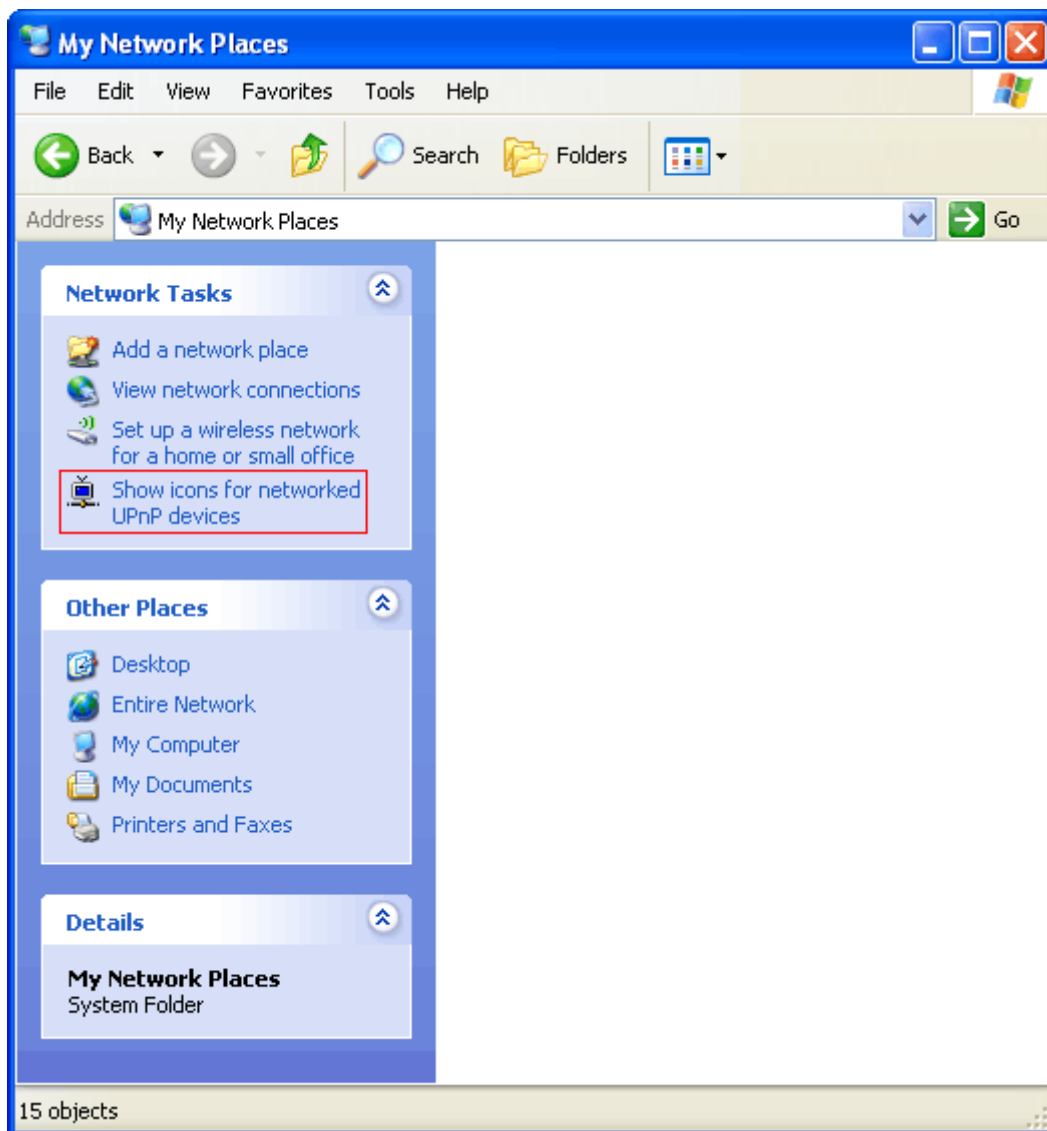

WARRANTY TERMS AND CONDITIONS

I. TERMS OF SALE: DEVA Broadcast Ltd. products are sold with an understanding of “full satisfaction”; that is, full credit or refund will be issued for products sold as new if returned to the point of purchase within 30 days following their receipt, provided that they are returned complete and in an “as received” condition.

II. CONDITIONS OF WARRANTY: The following terms apply unless amended in writing by DEVA Broadcast Ltd.

A. The Warranty Registration Card supplied with this product must be completed and returned to DEVA Broadcast Ltd. within 10 days of delivery.

B. This Warranty applies only to products sold “as new.” It is extended only to the original end-user and may not be transferred or assigned without prior written approval by DEVA Broadcast Ltd.

C. This Warranty does not apply to damage caused by improper mains settings and/or power supply.

D. This Warranty does not apply to damage caused by misuse, abuse, accident or neglect. This Warranty is voided by unauthorized attempts at repair or modification, or if the serial identification label has been removed or altered.

III. TERMS OF WARRANTY: DEVA Broadcast Ltd. products are warranted to be free from defects in materials and workmanship.

A. Any discrepancies noted within TWO YEARS of the date of delivery will be repaired free of charge, or the equipment will be replaced with a new or remanufactured product at DEVA Broadcast Ltd. option.

B. Parts and labor for factory repair required after the two-year Warranty period will be billed at prevailing prices and rates.

IV. RETURNING GOODS FOR FACTORY REPAIR:

A. Equipment will not be accepted for Warranty or other repair without a Return Authorization (RA) number issued by DEVA Broadcast Ltd. prior to its return. An RA number may be obtained by calling the factory. The number should be prominently marked on the outside of the shipping carton.

B. Equipment must be shipped prepaid to DEVA Broadcast Ltd.. Shipping charges will be reimbursed for valid Warranty claims. Damage sustained as a result of improper packing for return to the factory is not covered under terms of the Warranty and may occasion additional charges.

PRODUCT REGISTRATION CARD

- All fields are required, or warranty registration is invalid and void

Your Company Name _____

Contact _____

Address Line 1 _____

Address Line 2 _____

City _____

State/Province _____ ZIP/Postal Code _____

Country _____

E-mail _____ Phone _____ Fax _____

Which DEVA Broadcast Ltd. product did you purchase? _____

Product Serial # _____

Purchase date ____ / ____ / ____

Installation date ____ / ____ / ____

Your signature*

*Signing this warranty registration form you are stating that all the information provided to DEVA Broadcast Ltd. are truth and correct. DEVA Broadcast Ltd. declines any responsibility for the provided information that could result in an immediate loss of warranty for the above specified product(s).

Privacy statement: DEVA Broadcast Ltd. will not share the personal information you provide on this card with any other parties.