

SCOOP F ONE

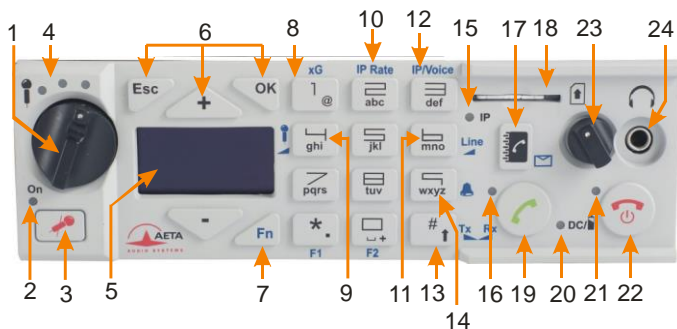

Getting started

Front panel & controls



1. **Microphone potentiometer:** controls the microphone level.
2. **Microphone indicator:** This red LED turns on when the microphone input is enabled.
3. **Microphone button:** Enables/mutes the microphone input.
4. **Microphone level:** 3-segment indicator (-20 dBFS / -12 dBFS / -3 dBFS).
5. **OLED display**
6. **Navigation keys:** Use the **Esc** key to access the configuration menu. Use the **Up/+** and **Down/-** keys to browse the selections and use the **OK** key to validate menu selections or messages.
7. **Function key:** Used in combination with other keys, it gives access to functions marked in blue. It is active for 5 seconds. This key is called **Fn** hereafter.
8. **Change Radio Access Technology:** When **Fn** is enabled, use this key to access the type of mobile network (Auto, 3G, 4G).
9. **Microphone gain:** When **Fn** is enabled, press this key **4** and use **+** key to increase and **-** key to decrease the gain of the microphone.

10. **IP Rate:** While an AoIP link is active, press **Fn**, press this key and use **+** key to increase and **-** key to decrease the bit rate.
11. **Line input level:** When **Fn** is enabled, press this key and use the **+** and **-** keys to increase/decrease the line input gain; the maximum (clipping) level of the input (from +4 dBu to +16 dBu) is displayed during the adjustment.
12. **IP / Voice:** When **Fn** is enabled, use this key to switch between the voice mode and the IP mode.
13. **Shift/Balance:** Switches the keypad to alphanumeric or numeric mode. When **Fn** is enabled, press this key and use **+** and **-** to adjust the send/receive balance for the headphone monitoring.
14. **Ringer shortcut:** When **Fn** is enabled, use this key to enable or disable the ringer.
15. **Network mode indicator:** This blue LED turns on when the IP mode is selected for outgoing calls.
16. **Communication indicator:** This green LED turns on when the communication is established.
17. **Phonebook:** Press the **Phonebook** key to access one of the memories or to save the current phone number into a memory. Or, while in **Fn** mode, access the received SMS.
18. **SIM Card slot**
19. **Call key:** Use the **Green phone** key to initiate a call.
20. **Power indicator:** The LED turns red when the battery is charging from an external power supply and green when it is fully charged.
21. **Alarm indicator:** The red LED turns on when an alarm triggers (PIN request, missing SIM, no network, sync loss...). The nature of the alarm is shown on the display.
22. **Hang up key:** Press the **Red phone** key to release a connection. Hold it for 2 seconds to start or switch off the ScoopFone 4G.
23. **Headphone volume:** Handles the level of the headphone connected on the ScoopFone 4G
24. **Headphone jack:** 3.5 mm stereo jack.

Rackmount version (ScoopFone 4G-R)

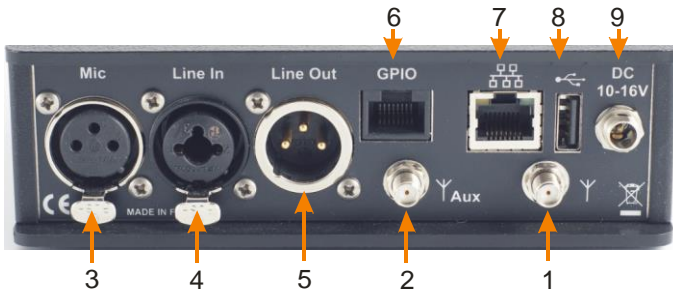

1. **Main antenna:** SMA socket
2. **Aux antenna:** SMA connector for the second antenna ("diversity" mode)
3. **Microphone input:** balanced input, gain switchable from 0 to 48 dB by 16 dB steps.
4. **Line input:** combo socket, balanced input (XLR), unbalanced input (6.35 mm jack), +16 dBu max.
5. **Line output:** balanced output, 3-pin XLR. Level adjustment via menu from +4 dBu to +22 dBu.
6. **GPIO:** RJ45 socket with 2 relays, 2 contacts and LPS power. (cable less than 1 m long). Pin assignment:

Contact	Function
1	+5 V / 500 mA
2	Contact 1
3	Contact 2
4	Contact common 1&2
5	Ground
6	Relay 1
7	Relay 2
8	Relay common 1&2

Portable version (ScoopFone 4G)

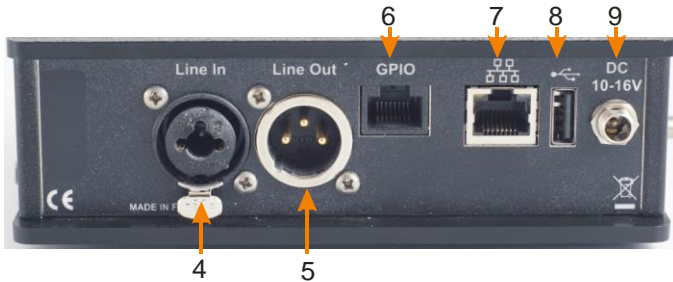

7. **Ethernet:** 10/100Mbit/s Ethernet interface
8. **USB A:** USB 2.0 Interface for memory import.
9. **DC Power:** 2.1 mm jack for external LPS DC power 10 to 16 V, 1.5 A max. Can also be used for charging the batteries.
10. **Headphone:** 6.35 mm jack (only on portable version).



Main screen

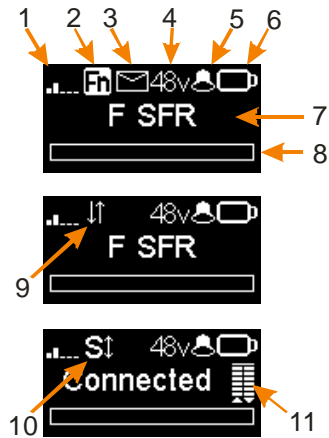

1. **Network level indicator:** 5-bar display.
2. **Function key indicator:** flashing when functions marked in blue are enabled by the **Fn** key.
3. **SMS reception indicator:** stays on until all the new SMS are read, using **Fn** and **Phonebook** keys.
4. **Microphone power indicator:** 48V phantom.
5. **Buzzer indicator**
6. **Battery level** (*portable version*): 5-segment display
7. **Mobile network operator name, current network**
8. **Audio send level:** From -30 dBFS to 0 dBFS.
9. **Data connection active.**
10. **SIP registration active:** on when the unit is registered on a SIP server
11. **Transmission quality:** 6-segment indicators, showing respectively the quality of the transmission and reception on the network

INTRODUCTION

We advise you to read this guide first to help you get familiar with the ScoopFone 4G in a short time. For more detailed information, please consult the full user manual on our web site:

www.aeta-audio.com

For this guide, we assume that the basic principles are known and that you have already connected a microphone and a headphone to the unit.

The ScoopFone 4G allows you to set up live mono audio connections in three possible ways:

- Standard telephone or "HD Voice" (7 kHz wide band) link over mobile 2G, 3G or 4G networks.
- Audio over IP (AoIP) connections over mobile 3G or 4G (LTE) networks.
- Audio over IP (AoIP) connections over an Ethernet wired access.

In IP mode, up to 20 kHz bandwidth is available with the OPUS algorithm (default algorithm). In case the remote unit does not support this algorithm, the connection will be established automatically with G722 or G711 coding.

AoIP connections are normally based on the SIP protocol. It is possible to use a "Direct RTP" mode without the SIP protocol: for such operation please refer to the detailed user manual.

This guide applies to units with firmware version 1.15 or newer.

SET UP

ScoopFone 4G can be operated under an ambient temperature of 0° to 45° C (32°F to 113°F).

Installation in a 19" rack (ScoopFone 4G-R)

If needed, a rack mount tray is available for integrating one to three ScoopFone HD-R or ScoopFone 4G-R units into a 1U space of a rack.

Powering

Before switching on the ScoopFone 4G, you need to have 6 AA batteries inserted in the bottom compartment, or an external DC power supply connected via the DC jack.

Batteries (Portable version only)

ScoopFone 4G works with NiMH batteries. Six 2500 mA.h NiMH batteries provide power for more than 5 hours of transmission.



In order to get an accurate charge level indication with rechargeable batteries, it is necessary, at least once, to leave the ScoopFone 4G on with the external DC power until it is fully charged.



CAUTION: THERE IS RISK OF EXPLOSION IF THE BATTERIES ARE OF A WRONG TYPE, OR ARE INSERTED THE WRONG WAY.

DISPOSE OF USED BATTERIES ACCORDING TO INSTRUCTIONS.

External power supply (indoor use)

The external DC supply is also used to charge the batteries. Only NiMH batteries are supported by the internal charger. You can use the provided LPS power adapter (GS25B12 or GST25B12), or another adequate LPS DC power source. ScoopFone 4G runs from a nominal 12 V, but it can run with a voltage from 10 to 16 V, with a maximum consumption of 1.5 A.

Antennas

The ScoopFone 4G uses female SMA sockets. You must connect at least one antenna on the rear panel. A second antenna is recommended to optimize the mobile operation. For the best efficiency, place the antennas as far as possible from each other.

SIM card

To establish mobile links, you should have a SIM card from a mobile telecom operator. ScoopFone 4G accepts standard size SIM cards; use a card adaptor if necessary for supporting a micro-SIM or nano-SIM card (Contact your dealer for more details).



Switch off the unit before inserting the SIM card

To insert the SIM card into the slot, follow the orientation marked on the front panel (contacts facing down, cut mark forward). As the SIM card holder is a push-push holder, you should push the SIM card as well to extract it.

Warning: for a new SIM card requiring activation (e.g. prepaid SIM card), you can use a mobile phone to perform the activation procedure.

You can do the same for disabling the call waiting tone (recommended for avoiding undesired tones during a report)

MAKING A CALL

Switching ScoopFone 4G on / off

To switch the ScoopFone 4G on, press  for 2 seconds.

To turn it off, press  for 2 s; a confirmation message is displayed. Press **OK** to confirm or **Esc** to cancel.

Enter the PIN code



If the PIN code is enabled on your SIM card, you must enter it and validate with **OK**. The PIN code can be saved using the menu.

Adjust the microphone level

Turn ON the mute LED indicator, using the mute key  if needed.

Set the **Potentiometer** ([1] on page 2) to its middle position (white dot of the button in the topmost position). Adjust the headphone balance (send/receive): enable the **Fn** mode and press the **#** key, then set the balance to the average position with the **+** and **-** keys.

Make a test with your microphone while watching the level indicators (above the potentiometer). If the level is too high or too low, enable **Fn** mode + key **4** and press key **+** to increase or key **-** to decrease the gain of the microphone, until you get the appropriate level.

From then on, you can use the potentiometer for fine adjustment.

Preparation: for Ethernet network (IP mode)

Connect the Ethernet Interface ([7] on page 3) of the ScoopFone 4G to the network. If the automatic network switch is disabled, you should select the Ethernet network through the **IP / IP interface** menu.

The blue **"IP"** LED shows the type of outgoing call that can be set up: LED **on** for the IP mode. If necessary, activate this mode using the shortcut **Fn + 3 (IP/Voice)**.

Preparation: for IP mode over a mobile network

If you have "Ethernet" displayed, disconnect the Ethernet cable from the ScoopFone 4G, or force the selection of the mobile network using the menu **IP / IP interface**.

The blue **"IP"** LED shows the type of outgoing call that can be set up: LED **on** for the IP mode. If necessary, activate this mode using the shortcut **Fn + 3 (IP/Voice)**.



For links over the Internet via an access router with NAT, we recommend using a STUN server. To enable it, enter the **IP / Use STUN** menu.

If you use your ScoopFone 4G in IP mode with a SIP server, you should have the  icon displayed on the screen.

Preparation: for IP mode over a mobile network

Receiving mobile phone calls is always possible regardless of the current mode; no specific setting is needed for receiving this type of calls.

However, before setting a call in mobile voice mode, you should first activate outgoing voice calls, using the shortcut **Fn + 3 (IP/Voice)**. The blue **"IP"** LED must be off.

Making a call

Enter directly with the keypad the call destination: phone number, IP address, or SIP identifier (URI).

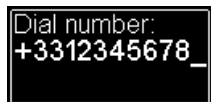

Press **UP** or **DOWN** to erase the last digit(s)/character(s).

Press the **0** key twice to get the international + symbol.

If needed, press the **#** key to access the alphabetic characters.

Press the  key to make the call. *Otherwise cancel using Esc or*





Using the phonebook

Enter a number as described above, and press the  key to save this number into one of the 99 memories of the current mode.

To recall a number from the phonebook, press the  key and enter the number of the desired memory from 01 to 99.



The number is displayed and you can:

- Set the call by pressing the  key.
- Cancel using **Esc** or .
- Edit the number using **+** or **-** before launching the call

For memories 01 to 09, you can also press directly one key (1 to 9) then OK to display the stored number.

During the call

To adjust the headphone balance, enable the **Fn** mode and press the **#** key. Adjust the balance as desired using the **+** and **-** keys.

Adjust the transmission bit rate in IP mode

You can adjust the transmission bit rate during an audio connection¹. Enable the **Fn** mode + **2 (IP Rate)** key. Using the **Up** and **Down** keys you can increase or decrease the bit rate.

Notes:

- The quality bars on the screen (see [11] on page 4) provide real time information on the transmission quality for both directions (but for the transmit direction, this depends on the remote unit's capability).
- If the connection is set with an AETA product at the other end, the bit rate also changes in the receiving direction, from the remote codec.

Hang up

Press  twice to hang up.

Redial

Press the key  twice to redial the last called number.

¹ If the link is set with the Opus coding algorithm.

How to get an HD Voice connection

To get an HD Voice connection, some conditions must be met:

- Both devices involved in the connection must support HD voice.
- HD voice must be supported by the mobile network.
- Usually, both units should be connected on the same mobile network (same carrier).
- Most often, 2G networks do not support HD voice. This depends on the country or area, and the network carrier.

For this last reason, the radio technology indication (2G, 3G, 4G display on the screen) is a useful indication that HD Voice is possible. In addition, it is possible to force the operation to 3G mode via the menu **Mobile / Mobile network**. You also have a shortcut with **Fn + 1 (xG)**.

How to turn on/off the ringer

Enable **Fn** mode and press **9** key to change the ringer state. When the ringer is off, the ringer icon on the display shows muted.

Reading SMS

Enable **Fn** mode and press the  key to show the list of the received SMS.

If you have got several, press **OK** to read the selected SMS. Press the **Esc** key to keep it, otherwise **OK** to delete it.

IMPORTING MEMORIES

You can import a phonebook into the ScoopFone 4G using a USB memory stick.

To do this, place a "book-scoopfone.txt" import file on the root of the USB drive and plug it into the ScoopFone 4G after it has started.

The import file must have the following format:

Memory number: type of memory, phone number or SIP URI

- Memory number : 1 to 99
- Type of memory : 0 for voice , 1 for IP

Example:

1:0,0141361268

2:0,0141361279

1:1,30000

2:1,15000@sip.aeta-audio.com

35:1,10.0.20.123:5063



Note: importing a file completely clears the previous phonebook; all the memories are reconfigured or erased.

MENU

Navigation: use the **Esc** key to access the configuration menu. Use the **Up/+** and **Down/-** keys to browse the selections and use the **OK** key to enter a sub-menu, validate menu selections or messages.

First menu level:

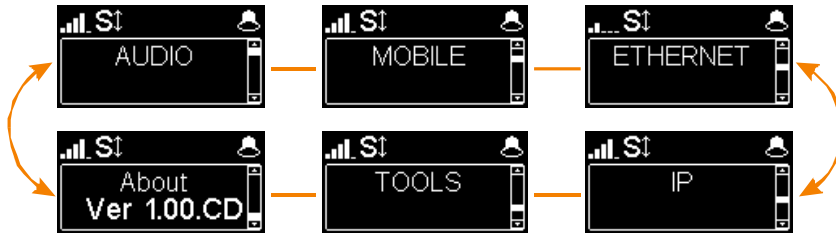

Audio: menu for configuring the audio interfaces

Mobile: configuration of the internal mobile access module

Ethernet: configuration of the Ethernet interface

IP: configuration of the IP transmission mode

Tools: user interface configuration, reset settings

About: shows information on the ScoopFone 4G such as:

- Firmware version number
- SIM card phone number
- SIP account and server address
- Ethernet interface IP address
- Reference of the internal radio module

AUDIO MENU



Microphone phantom power

You can enable 48 V phantom power



Selection of microphone button operation

Flip-flop : switch the input between enabled and disabled

Push to talk : keep the key pressed to enable the microphone input

Cough key : keep the key pressed to mute the microphone input



Line output level adjustment

The maximum output level can be set from +4 dBu to +22 dBu.



Line output source selection

You can select between the transmit signal (*Send*), the received signal (*Receive*) and the headphone balance (*Balance*).



Echo cancellation

You can enable local echo cancellation.

Note : this echo cancellation is active only for the mobile VOICE mode



Noise gate

You can enable background noise suppression on the sent signal.

Note : this function is active only for the mobile VOICE mode

MOBILE MENU



Set the mobile Radio Access Technology

You can force the mobile on a specific radio technology: 2G, 3G, 4G, or just let the mobile module select the best available network by using the **Auto** mode (recommended).

It is also possible to force the selection of the mobile operator, by using an extended menu. See below how to activate this menu.



Enable mobile data transmission

You can disable *mobile* data transmission via the mobile network.

Note : this does not affect the IP data transmission over the Ethernet interface



Set the mobile operator APN

The ScoopFone 4G features a preset APN for each operator. You can enter another one if this preset is not suitable, or if the operator is not included in the internal list of presets.

Note: to reload the APN from the internal list, you should erase the current one and then restart the unit.



Line quality setting

This setting adapts the size of the reception jitter buffer depending on the expected transmission quality (the lower quality, the bigger buffer for compensation).

"Low" is recommended for a mobile data link. The "Very high" setting provides the minimum latency, but is also *more sensitive to possible jitter on the network*.

Alternative: if the "Auto Jitter Buffer" system is activated (see IP menu below), this setting becomes "AJB Policy": selection of the policy for this system

Extended menu:

There is a menu, reserved for advanced users, that also allows selecting manually the mobile network you want to connect to.

To activate this extended menu:

- Switch to IP mode if necessary (**Fn** key, then **IP/Voice**)
- Hit the following key sequence: **1 Up # # @ A E T A @** (display : @AETA@)
- Validate with the call key 

From then on, the extended menu is accessible until the ScoopFone 4G is switched off.

ETHERNET MENU

*Note : changes made by using this menu are only effective after exiting the menu (**Esc** key to go back to the upper level).*



Set Ethernet IP address allocation

Select DHCP on a network equipped with a DHCP server, otherwise select Manual to set a static IP address.



IP address

For static IP addressing, enter here the IP address.



Set network mask

For static IP addressing, set/change here the network mask.



Set Ethernet gateway

For static IP addressing, set/change here the default gateway address.



Set DNS 1

For static IP addressing, set/change here the numeric address of the domain name server.



Display the Ethernet MAC address

Press **OK** to see the complete address.



Line quality setting

This setting adapts the size of the reception jitter buffer depending on the expected transmission quality (the lower quality, the bigger buffer for compensation).

Alternative: if the "Auto Jitter Buffer" system is activated (see IP menu below), this setting becomes "AJB Policy": selection of the policy for this system.

IP MENU

Note: changes made by using this menu are only effective after exiting the menu (Esc key to go back to the upper level).



IP interface selection

With this menu, you can force the Ethernet or the mobile data network for outgoing call in IP mode. In Auto mode, the IP interface switches to Ethernet when an Ethernet cable is connected. Conversely, whenever the Ethernet cable is disconnected, the ScoopFone 4G switches to the mobile data network.



Set the default IP transmission bit rate (OPUS)

Here you can set the preferred bit rate for the OPUS coding, from 12 kbit/s to 192 kbit/s.

Note: this is the initial bit rate, when the link is established; afterwards the bit rate can be changed during the transmission if the connection is done with OPUS.



Activate the automatic bit rate system (OPUS)

This menu allows to activate the auto bit rate adjustment, and select the preferred system policy: "Safe" applies slower variations to avoid audio disturbance, "Punchy" seeks a faster adaptation to changes in transmission quality.



Activate "Auto Jitter Buffer"

This menu allows to activate the adaptive adjustment of the jitter buffer size.

Note: latency is variable when using this system.

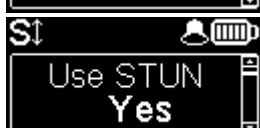

Enable STUN

Using STUN is usually recommended when using a SIP server; however this is not suitable in some cases. As a general rule, enable STUN. If you meet connectivity issues (such as failure to sync when starting the connection, or link loss after a few seconds), disable the function.



Type of NAT (Network Address Translation)

When STUN is used, the ScoopFone 4G can detect the type of NAT performed by the router through which it accesses the Internet. *In case the router applies symmetric NAT, it is usually recommended to disable STUN.*



Display the public IP address

When STUN is used, the ScoopFone 4G can detect the public IP address, with which it accesses the Internet.





Default AoIP protocol

AoIP connections normally use the SIP protocol. By selecting here "Direct RTP" it is possible to make calls without the SIP protocol. The various parameters of this "Direct RTP" mode are available only via the embedded html pages. *The operation mode is described in the detailed user manual.*

Change displayed SIP name

You can enter a name that will be displayed on the remote unit (depending on its type and settings).

Display your SIP account number

The SIP account data are normally entered/edited by using the web interface of the ScoopFone 4G.

Server SIP port

The default SIP port for the server is 5060. In some cases it is useful to use the alternate port 5070. You can also set any other port value by using the web interface, or the extended IP menu (see below).

RTP port for the audio stream (display only)

This port can be changed through the web pages or the extended IP menu (see below).

Activate packet duplication (double stream)

When this feature is enabled, a double stream is sent, for a more robust transmission.

Extended menu:

Some parameters of the Audio over IP (AoIP) operation are not normally accessible via the IP menu, or they can only be read but not edited. However, there is a mode, reserved for advanced users, that provides full access to all the AoIP parameters.

To activate this extended menu:

- Switch to IP mode if necessary (Fn key, then IP/Voice)
- Hit the following key sequence: **1 Up # # @ A E T A @** (display : @AETA@)
- Validate with the call key 

From then on, the extended menu is accessible until the ScoopFone 4G is switched off.

TOOLS MENU



Save PIN in the ScoopFone 4G

If you select "On", the PIN code is saved into the ScoopFone 4G and you need not enter it again every time the unit is switched on (as long as the same SIM card stays inside the unit). *If the recorded PIN is invalid (e.g. after inserting another SIM card), the saved PIN is deleted and the function is cancelled.*



Automatic or manual answer

You can specify the number of rings before automatically answering calls, or select manual answering.



Incoming call filtering

With "White list", only the telephone calls (mobile voice) from numbers included in the phonebook are accepted.

Note : this feature is available only on the rack mount version ScoopFone 4G-R



Auto redial

"On" activates the auto redial feature. In such case, when the ScoopFone 4G calls a remote unit, it automatically redials the number whenever the link is dropped unexpectedly. The parameters of this function are available via the embedded html pages.

Caution: you must hang up from the ScoopFone 4G for releasing the link once and for all.



Enable DTMF

If enabled, DTMF tones can be sent during a mobile voice connection, by using the keypad (numeric keys, * and #).



TOOLS MENU (continued)



Function: contact 1

Can be used to make a call with memory 1, or transmit an "Info 1" state.

Note : the contact can operate on a transition (Switch) or a pulse (Pulse) for calling/hanging up a call.



Function: contact 2

Can be used to make a call with memory 2, or control the microphone input mute, or force 3G mode, or force 4G mode, or force the Voice mode, or force the IP mode, or transmit an "Info 2" state.

Note : the contact can operate on a transition (Switch) or a pulse (Pulse) in order to call/hang up a call. Other assignments are sensitive to the contact state.



Function: relay 1

Relay 1 signals the connection state : connected (closed), on hook/idle (open), call in progress (blinking open/closed), or signals the received "Info 1" state.



Function: relay 2

Relay 2 provides a selectable status:

None, Ready, SIP ready, Ring, 3G, 4G, Voice mode, IP mode, or received "Info 2" state.



Display brightness adjustment

3 brightness levels are available: Low, Normal, High



Reset settings

- Reload the factory SIP account
- Reset all settings, *including the SIP account data.*

WEB INTERFACE

Once the ScoopFone 4G is connected on an IP network, the first step is to get its IP address, from the menu: [About](#), or the menu [Ethernet / IP Address](#). On the control computer, launch an html browser and enter the IP address of the ScoopFone 4G in the "address" or "URL" field. This gives access to the html server integrated in ScoopFone 4G, for extended status and control features.

The screenshot displays the ScoopFone 4G web interface. At the top, there is a header with the AETA Audio Systems logo, the product name 'SCOOPFONE 4G', and a 'Login' button. Below the header is a navigation menu with tabs for STATUS, CONNECTIONS, PROFILES, NETWORK, AUDIO, CODING, MISC, and MAINTENANCE. The main content area is divided into several sections:

- Refresh All**: A red refresh icon and text.
- GENERAL**:
 - Current Network: Mobile (Int.)
 - Coding: OPUS 48kHz 32kbit/s Mono
 - SMS: On
- AcIP**:
 - SIP Registration: On
 - SIP Registrar: sip.aeta-audio.com:5070
 - SIP User: 902077
 - SIP Status: Registered
- CONNECTION STATE**:
 - Status: Established
 - Network: Mobile (Int.)
 - 1. Remote Address: 902086
 - Coding Algorithm (Tx): OPUS 48kHz 32kbit/s Mono
 - Coding Algorithm (Rx): OPUS 48kHz 32kbit/s Mono
 - Reception Quality: 35%
- ETHERNET**:
 - Mode: DHCP
 - IP Address: 10.0.20.60
 - Subnet Mask: 255.255.255.0
 - Gateway: 10.0.20.254
 - DNS Server 1: 10.0.20.3
 - DNS Server 2:
 - Link Mode: 100BaseT-FD
- MOBILE (INT.)**:
 - Mode: IP Mode
 - Network: Orange F
 - Mobile network type: HSPA+
 - Signal strength: -77 dBm
 - Data Service: Active
- Signal Strength Indicator**: A vertical bar chart showing signal strength in dB. The scale ranges from 0 dB at the top to -30 dB at the bottom. The Tx (Transmit) bar is green and reaches approximately -18 dB. The Rx (Receive) bar is green and reaches approximately -12 dB.

At the bottom of the interface, there is a footer with the text: AETA AUDIO SYSTEMS - VISIT WWW.AETA-AUDIO.COM and VERSION: 1.00.CD - SW BUILD: 2015-09-11.

HOW TO ...

Be ready to make mobile voice calls and receive AoIP calls on the Ethernet IP link (recommended configuration for the studio side).

- ⇒ Disable mobile data
Menu **Mobile / mobile data** : OFF

Avoid getting AoIP (Audio over IP) links blocked/corrupted by mobile networks

- ⇒ Some operators require the subscription of a VoIP option to allow streaming (RTP stream authorization)

Avoid unwanted voice calls

- ⇒ Select « White list » in the menu **Tools / Incoming calls**. Only calls from numbers in the phonebook will be accepted. This feature is only available on the rackmount version.

Update the ScoopFone 4G firmware

- ⇒ Either from the html interface
- ⇒ Or with a USB key: menu **Maintenance / System update** (beforehand, add the update file in the root directory of the disk).
- ⇒ *For more details, refer to the web page dedicated to the ScoopFone 4G on our web site www.aeta-audio.com.*

Remote control the ScoopFone 4G (via Internet)

- ⇒ Refer to the application note "[Using the AETA Remote Access service](#)"

TROUBLESHOOTING

The  icon is not displayed while in Ethernet mode

- ⇒ Check that the Ethernet cable is connected

The  icon is not displayed while in mobile IP mode

- ⇒ Check/correct the APN; if needed try to reload the default APN (see **Mobile** menu)

The  icon is not displayed

- ⇒ Change the «Server SIP port» (AETA server)

The  icon is displayed, but the audio does not go through, or stops after several seconds.

- ⇒ Enable or disable STUN
- ⇒ Change the RTP port

The audio stream is corrupted in mobile IP mode

- ⇒ Check whether a VoIP option is required by the mobile operator
- ⇒ If the transmission quality bars are low :
 - Decrease the network quality, Menu **Mobile / Net quality** (affects the *receive* direction)
 - Enable the packet duplication, Menu **IP/Packet repl.** (affects the *send* direction)

You can't change the bit rate during the connection (shortcut **Fn+2 (IP/Rate))**

- ⇒ This feature is only available with OPUS, so the remote unit must support this codec.

AUDIO DIAGRAM

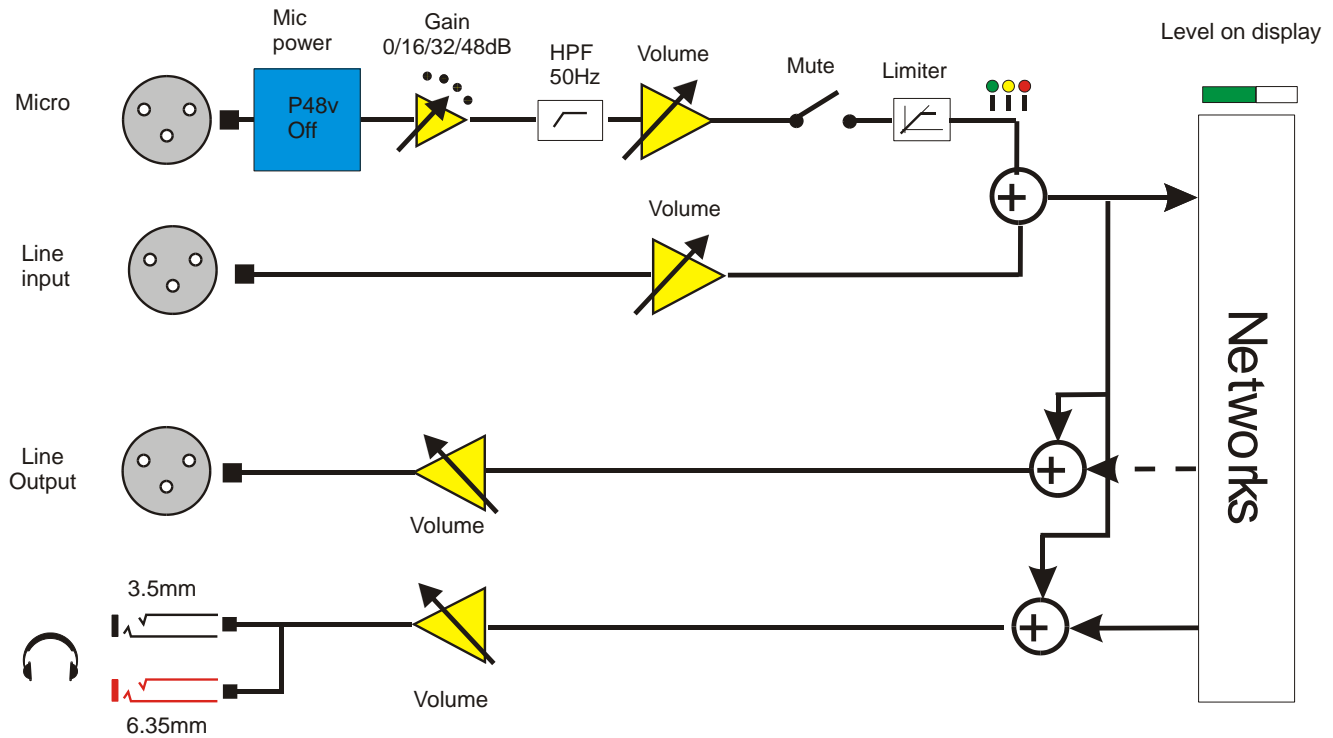

ACCESSORIES



Car battery adapter



Spare AC/DC adapter



Multiband Antenna



Carrying bag



Carrying bag with accessory pouch

AETA Test numbers *

IP : 200@siptest.aeta.com

IP : 15000@sip.aeta-audio.com

APN codes (France) *

ORANGE : orange-mib

BOUYGUES : mmsbouygtel.com

SFR : sl2sfr

FREE : free

Your numbers

** Information valid at the date of issue of this document, and possibly depending on the terms of the subscription to mobile data networks*