

# SCOOP F ONE



Getting started

Specifications are subject to change without notice

55 000 075-E © 2017

## Front panel & controls

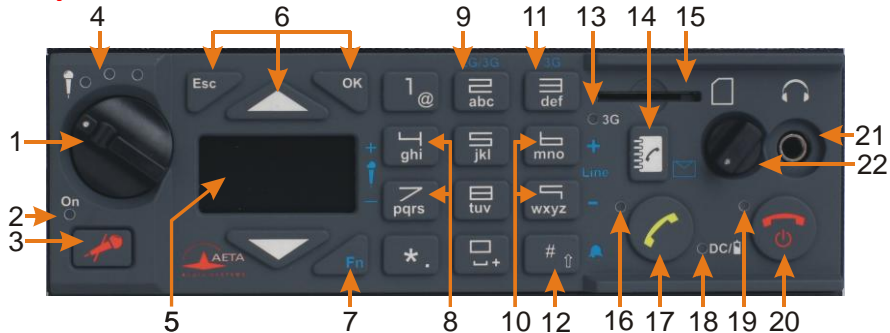

- 1. Level control:** This potentiometer controls the microphone level.
- 2. Mute indicator:** The LED turns red when the microphone input is enabled.
- 3. Mic button :** To enable/disable microphone input
- 4. Microphone level status:** The microphone has a 3 segment indicator (Over -20dBFS / -12dBFS / -3dBFS).
- 5. OLED Screen**
- 6. Navigation keys:** Use the **Esc** key to access the configuration menu. Use the **Up** and **Down** keys to navigate between choices and use the **OK** key to validate menu choices or messages.
- 7. Function key:** Used in combination with other keys, it gives access to functions marked in blue. It is active for 5 seconds. This key is called **Fn** hereafter.

8. **Microphone gain:** When **Fn** is enabled, use key **4** to increase and key **7** to decrease gain of the microphone.
9. **Network auto:** When **Fn** is enabled, use this key to select the automatic network selection (2G & 3G).
10. **Line gain:** When **Fn** is enabled, use key **6** to increase and key **9** to decrease gain of the line input.
11. **Network 3G:** When **Fn** is enabled, use this key to force the 3G network (See §: To get HD).
12. **Buzzer shortcut:** When **Fn** is enabled, use this key to enable or disable the buzzer.
13. **Network indicator:** The LED turns blue when 3G network is reached.
14. **Book key:** Press **Book** key to access one of 9 memories or to save current phone number into a memory. Or access to your SMS with in **Fn** mode
15. **SIM Card slot**
16. **Communication indicator:**

The LED turns green when the communication is established.
17. **Call key:** Use the **Green phone** key to initiate a call.
18. **Power indicator:** The LED turns red when the battery is charging from an external power supply and green when it is fully charged.
19. **Alarm indicator:** The LED turns red when an alarm occurs (PIN request, SIM missing, no network...). Details of the alarm are shown on the display.
20. **Hang up key:** Press the **Red phone** key to release a connection. Holding it for 2 seconds to start the ScoopFone
21. **Headphone socket:** 3.5mm stereo jack.
22. **Headphone level:** Handles the level of the headphone connected on the ScoopFone.

## OLED Screen

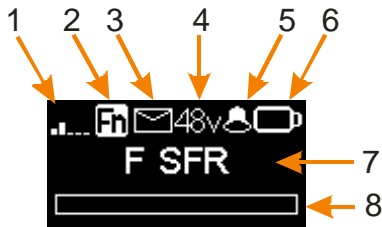

1. **Network level indicator:** 5 levels.
2. **Function key indicator:** flashing when blue functions are enabled by the **Fn** key.
3. **SMS reception indicator:** stay displayed until all the new SMS are read, using **Fn** and **Book** keys.
4. **Microphone power indicator:** 48V phantom.
5. **Buzzer indicator**
6. **Battery level:** 5 levels
7. **Mobile network operator name**
8. **Transmit audio level:** From -30 dBFS to 0 dBFS.

## INTRODUCTION

We advise you to read this quick guide to start using the ScoopFone in a very short time. For more detailed information on each step, do not hesitate to consult the full user manual on our web site:

[www.aeta-audio.com](http://www.aeta-audio.com)

The easy-to-use ScoopFone is designed for the needs of journalists. The 7 kHz wideband sound quality allows the full signature character of the reporter's voice to be heard, leading to greater audience involvement and loyalty

In this guide, we assume most of the main basics are known and that you already have a microphone and a headphone connected.

## SETTING IT UP

### Powering

Before switching on the ScoopFone, you need to have 6 AA batteries inserted in the bottom compartment, or an external DC power connected on the DC jack.

### Battery

ScoopFone works with non rechargeable or NiMH batteries.

Six 2500mAh NiMH batteries provide autonomy for more than 5 hours.



### External power supply

You can use an external power DC. ScoopFone needs 12V DC but is able to work with voltage from 10 to 16V / 1A minimum.

The external DC supply is also used to charge the batteries. Only NiMH batteries are supported by the internal charger.

**DON'T USE THIS INPUT WITH NON RECHARGEABLE BATTERIES.**

### Antenna

The ScoopFone uses SMA bulkhead female connectors. You must connect one main antenna (a right angle antenna is delivered in standard). You can connect a second antenna on the AUX connector to improve the reception. The second antenna should be enabled by menu.

## SIM card

To establish communication, you should have a SIM card from a telecom operator. ScoopFone supports standard SIM size, use a card adaptor to support micro SIM Card (Contact your dealer for more details).

To insert the SIM card into the slot, follow the orientation on the front panel (downward contact, insert the mitred corner facing forward). As the SIM card holder is a push-push holder, you should push the SIM card to extract it.

Warning: For new SIM card, use a mobile phone to activate your prepaid SIM card and disable second call.

## SET A CALL

### Switching ScoopFone on /off

To switch ScoopFone on, press  2 seconds.

To turn it off, press  key 2s, a confirmation message will be displayed. Press **OK** to switch off or **ESC** to cancel.

### Enter your PIN code



If the PIN code is enabled on your SIM CARD, you should enter it and validate with **OK**. Pin code can be saving by menu.

## Set a call

Enter directly your phone number with the digital keypad.



Press the **0** key twice to have the international **+** symbol.

Press **UP** or **DOWN** to erase last digit.

Press  key to launch the call.

Or

Press  key to save this number into one of the 9 memories.

## Set a call with a memory

Press  key and enter the number of requested memory from 1 to 9.

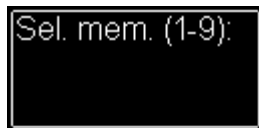

The number appears and you can establish the communication with the

 key

Or

- Cancel by **ESC** / 
- Modify the phone number by pressing **UP** or **DOWN**

## Redial

Press the key  to access to history call list. Select the number and press

 again.

You can delete the history call list through the last line.

## Adjust your microphone level

Turn ON the mute LED indicator with the mute key .

Set the **Level control (1)**, on middle position, white dot of the button in topmost position.

Make a test with your microphone. If the level is too high or too low on the display and LED bargraph, enable **Fn**

mode and press the key **4** to increase or the key **7** to decrease the gain of the microphone until you get the right level.

## Hang up

Press  twice to hang up.



## Line input adjustment

The line input is mixed with the microphone input. To adjust the line level, enable **Fn** mode and press the key **6** to increase or the key **9** to decrease the line input level until you get it right. At the minimum value the input line is completely muted.

## To get HD Voice

To get a HD Voice connection, some conditions are requested:

- Both devices in the connection must support HD voice
- Support of HD voice by your mobile operator's network
- Very often, only the 3G network supports HD voice. This depends on the country or area, and the operator.

For this last reason, having a connection on 3G can be a condition to get HD

Voice. In this case, the 3G LED is a useful indication that HD Voice is possible. In addition, it is possible to force operator on 3G mode: enable **Fn** mode and press key **3**.

To restore the automatic network selection, enable **Fn** mode and press key **2**.

## How to turn on/off the buzzer

Enable **Fn** mode and press **#** key to change the buzzer state.

When the buzzer is off, the buzzer icon on the display is stroked.

## SMS management

Enable **Fn** mode and press  key to show the list of received SMS.

If you have many, press **OK** to read the selected SMS. Press **Esc** key to keep it, otherwise **OK** to delete it.

## How to improve network reception

You can connect a second antenna on the AUX antenna connector and enable it by menu.

**WHEN YOU REMOVE THE AUX ANTENNA DON'T FORGET TO DISABLE THIS FEATURE BY MENU**

## Import

You can import a phonebook in your ScoopFone via a USB stick  
You should put a "book-scoopfone.txt" file in the root of the USB drive and plug it into the ScoopFone once started.

The file must have the following format:  
Memory number: phone number

Ex:

1:0141361268

2:0141361279

Note: All memories will be set or erased

## MENU



### Line output level adjustment

You can select maximum output level from -9dBu to +21dBu



### Microphone phantom power

You can enable 48Volts phantom power



### Microphone button

You have 3 functions available :

- Flip-flop : change the microphone input state between enabled and disabled
- Push to talk : The key should be keep pressed to enable the microphone input
- Cough key : The key should be keep pressed to disable the microphone input



#### **Echo cancel**

You can enable a local echo cancellation



#### **Noise Gate configuration**

You can enable noise suppression on the mixed signal



#### **Audio Balance between Send and Receive**

Available settings: Rx only, Rx +1/3Tx, Rx+Tx

Rx = Reception from the network

Tx = Transmission to the network



#### **Auxiliary antenna**

Should be set to “connected” only when a second antenna is connected on the AUX SMA connector on the rear panel.



<b>PIN save</b>
On Off If a wrong pin is enter, PIN save option will switch to off. The PIN is saving only if it is correct.



<b>Enable DTMF</b>
Capability to send DTMF tones during an active call through digital keypad.



<b>Automatic or Manual answer</b>
You can specify the number of RINGs before automatically answering or set it to manual answer.



<b>Display brightness adjustment</b>
You have 3 levels of adjustment for the brightness : Low, Normal, High

## Rear side panel

**Line OUT:** 3 pins XLR balanced output. Level adjustment via **Menu**  
**Max output : +21dBu**

**Line In:** balanced analog input with line level on 6.35mm jack.

**DC Power:** 2.1mm jack for external additional DC power 10 -16 V. Can also be used for connecting an AC/DC adaptor



**USB A:** USB1.1 interface for firmware updates

**Aux Antenna:** SMA connector for a second antenna (diversity mode)

## Left side panel

**Main Antenna:** SMA connector to connect the antenna



## Right side panel

**Headphone:**  
Stereo 6.35mm Jack  
Compatible with headphone  $\geq 16 \Omega$ .



**Mic/Line IN:** balanced analog adjustable gain from 0 to 48 dB by 16dB steps.  
Max acceptable level: +19

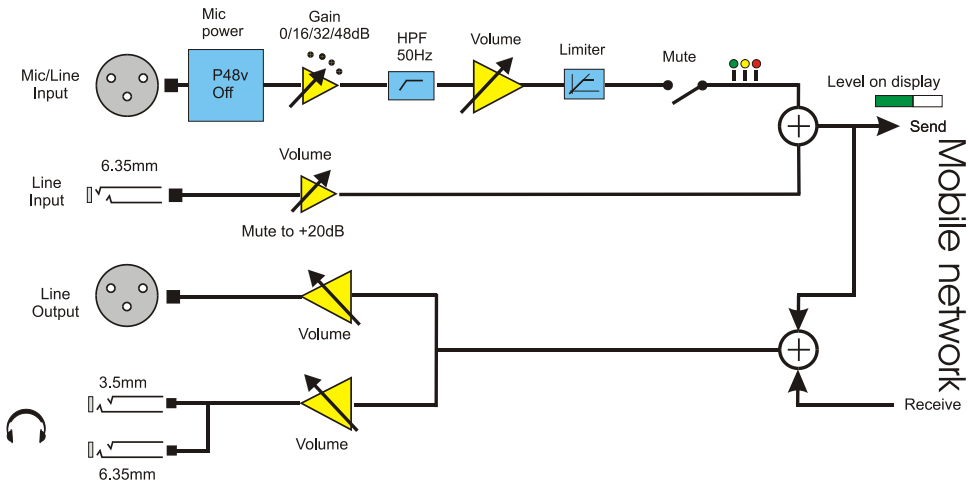

[www.aeta-audio.com](http://www.aeta-audio.com)